

# MUSCLE PHYSIOLOGY

賴亮全

辦公室：生理所1009室

院內分機：88241

E-mail: llai@ntu.edu.tw

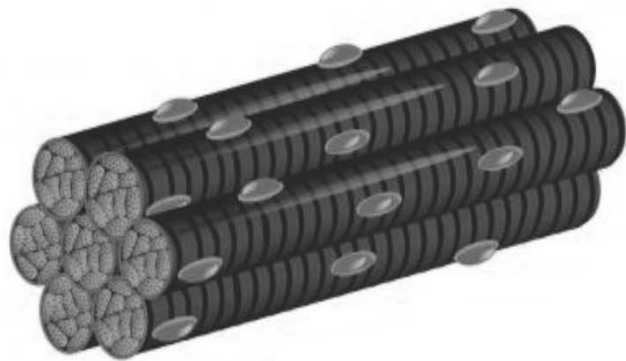

# Goals of the Lecture

- Explain the process of skeletal m. contraction
- Explain how to control skeletal m. contraction
- Interpret the mechanics of skeletal m. contraction
- Summarize the energetics of skeletal m. contraction
  
- Explain the process of smooth m. contraction and relaxation
- Classify different types of smooth m.
  
- Describe the characteristics of cardiac m.
  
- Differentiate the difference among three types of muscle

# Outlines

1. Background
2. Skeletal Muscle
  - Architecture & Structure
  - Sliding Filament Model of M. Contraction
  - Process of Skeletal M. Contraction
  - Control of Skeletal M. Contraction
  - Mechanics of Skeletal M. Contraction
  - Energetics of Skeletal M. Contraction
3. Smooth Muscle
  - Structural Characteristics
  - Smooth Muscle Contraction & Relaxation
  - Classification of Smooth Muscle
4. Cardiac Muscle

# Characteristics & Functions of Muscle

- **Characteristics**

- Excitability: ability to receive and respond to stimuli
- Contractility: ability to shorten and thicken
- Extensibility: ability to be stretched (extended)
- Elasticity: ability to return to original shape after contraction or extension

# Characteristics & Functions of Muscle

- **Functions**

- Motion

- Obvious: whole body walking, or grabbing

- Less obvious: heart, stomach, intestines, urinary bladder

- Maintenance of posture: muscle tone

- Stabilization of joints

- Heat production: 85% of all body heat is generated by muscles

# Morphological Classification of Muscle

- Striated m.
  - Voluntary m.: Skeletal m.
    - White m.
    - Red m.
  - Involuntary m.: Cardiac m.
- Smooth m.
  - Involuntary m.:
    - Single unit smooth m.
    - Multiunit smooth m.

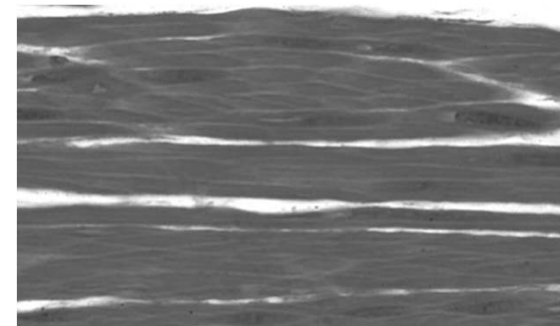
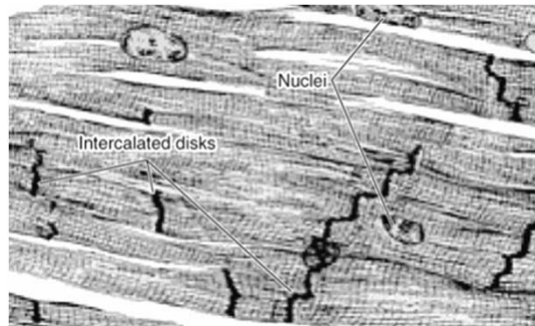
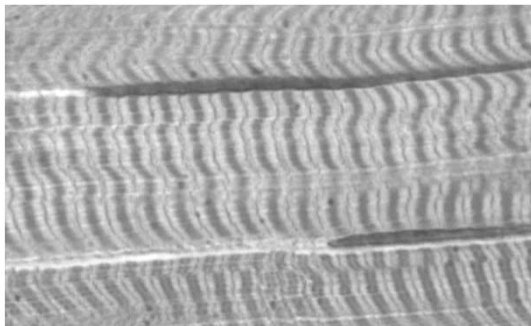
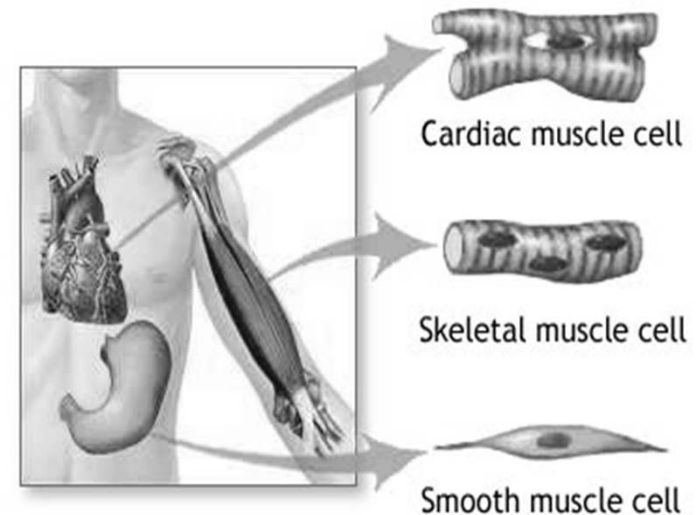

# Muscle Type and Activity

## Muscle types

### Skeletal muscle

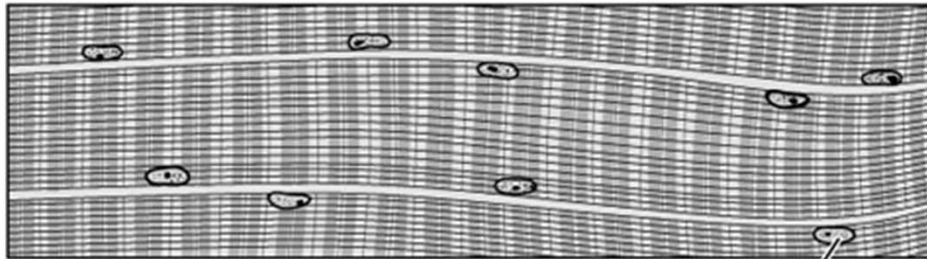

Nuclei

### Cardiac muscle

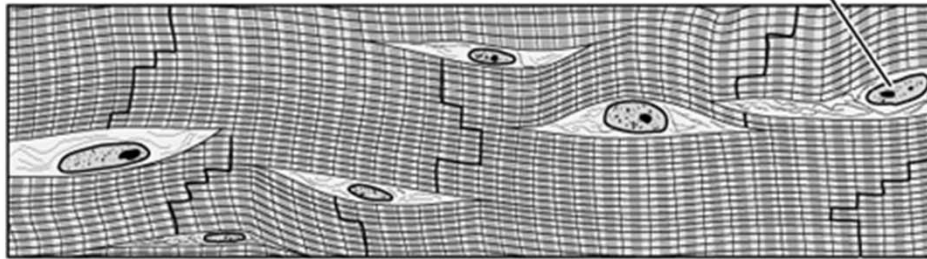

Intercalated disks

### Smooth muscle

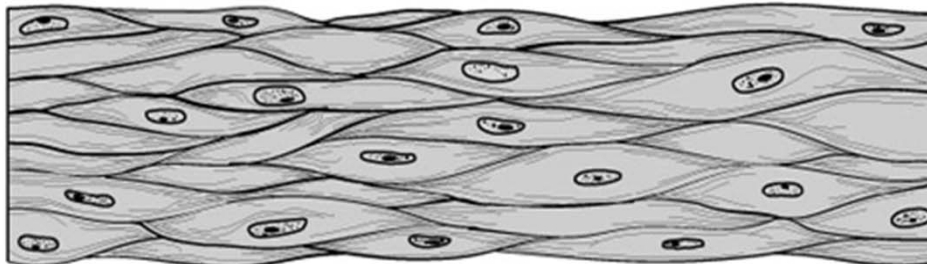

## Cross sections

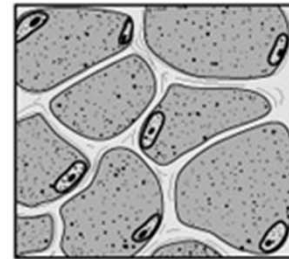

## Activity

Strong, quick  
discontinuous  
voluntary  
contraction

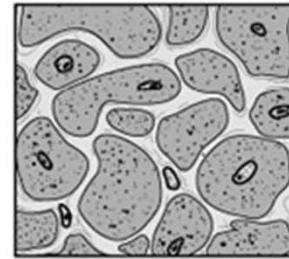

Strong, quick  
continuous  
involuntary  
contraction

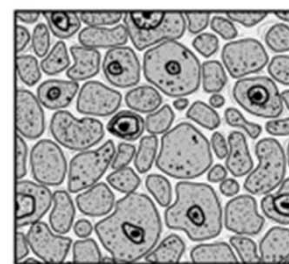

Weak, slow  
involuntary  
contraction

# Outlines

1. Background
2. Skeletal Muscle
  - Architecture & Structure
  - Sliding Filament Model of M. Contraction
  - Process of Skeletal M. Contraction
  - Control of Skeletal M. Contraction
  - Mechanics of Skeletal M. Contraction
  - Energetics of Skeletal M. Contraction
3. Smooth Muscle
  - Structural Characteristics
  - Smooth Muscle Contraction & Relaxation
  - Classification of Smooth Muscle
4. Cardiac Muscle



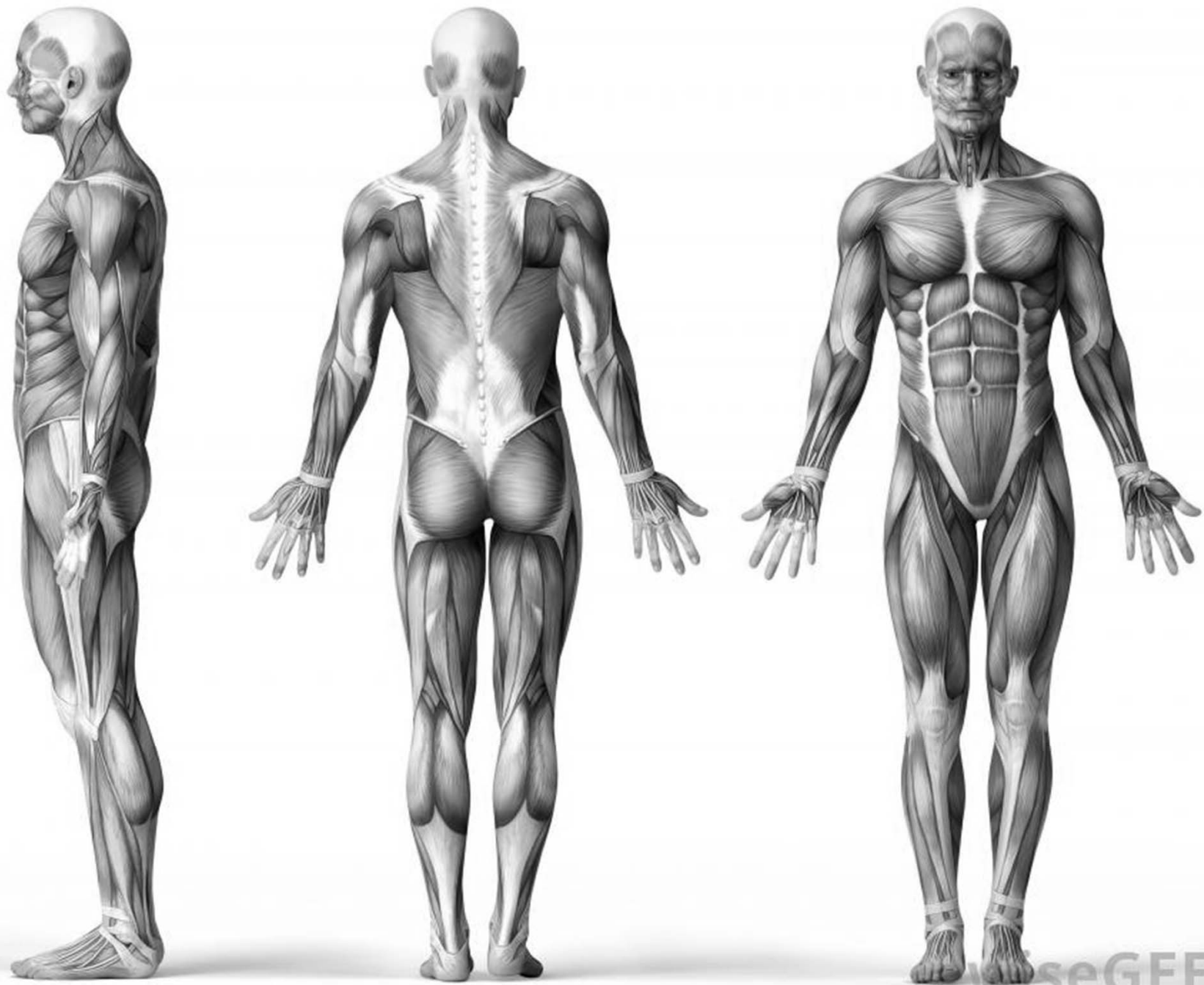

# Outlines

1. Background
2. Skeletal Muscle
  - Architecture & Structure
  - Sliding Filament Model of M. Contraction
  - Process of Skeletal M. Contraction
  - Control of Skeletal M. Contraction
  - Mechanics of Skeletal M. Contraction
  - Energetics of Skeletal M. Contraction
3. Smooth Muscle
  - Structural Characteristics
  - Smooth Muscle Contraction & Relaxation
  - Classification of Smooth Muscle
4. Cardiac Muscle

# Shapes of Skeletal Muscle

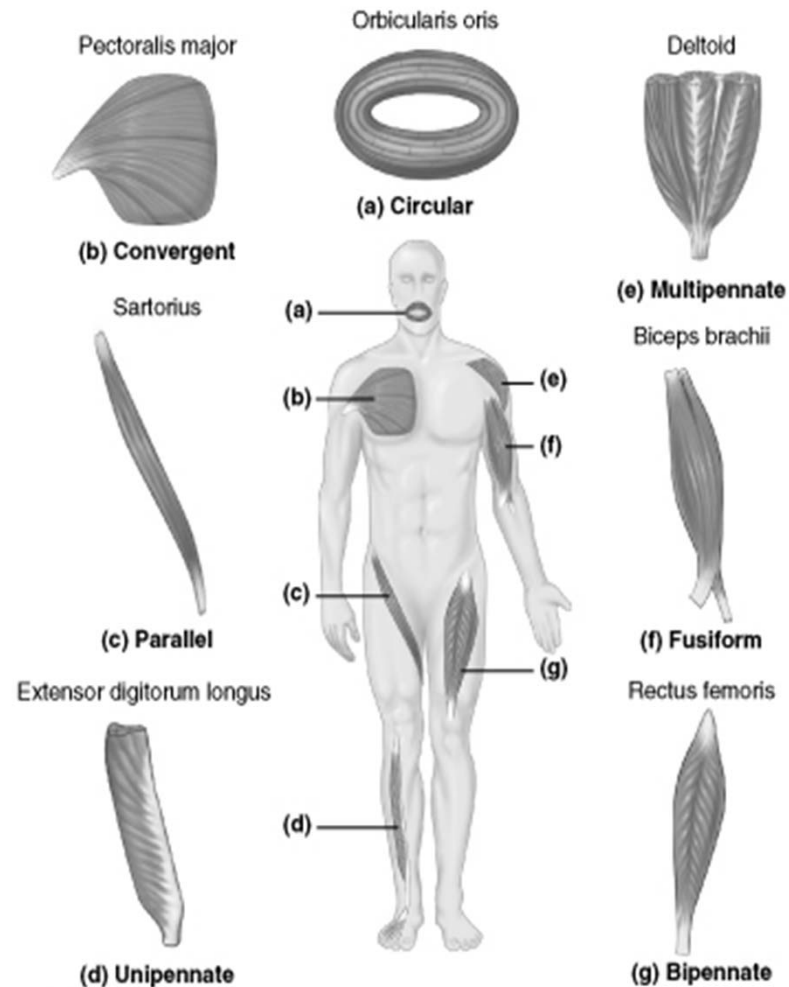

Copyright © 2001 Benjamin Cummings, an imprint of Addison Wesley Longman, Inc.

- Circular: act as a sphincter
- Convergent: to max the force
- Parallel: over a great distance
- Pennate
  - Unipennate
  - Bipennate
  - Multipennate
- Fusiform: like parallel m (spindle shaped)

# Skeletal Muscle Action

- A skeletal muscle connects two bones. When a muscle contracts, it shortens. (Ligament (韌帶): connects two bones directly)
  - This places tension on tendons (肌腱) connecting it to a bone
  - This moves the bone at a joint
  - The bone that moves is attached at the muscle insertion
  - The bone that does not move is attached at the muscle origin.

Category	Action
Extensor	Increases the angle at a joint
Flexor	Decreases the angle at a joint
Abductor	Moves limb away from the midline of the body
Adductor	Moves limb toward the midline of the body
Levator	Moves insertion upward
Depressor	Moves insertion downward
Rotator	Rotates a bone along its axis
Sphincter	Constricts an opening

The main muscles responsible for movement  
→ in the same direction are the agonists (協同肌)  
→ in an opposite direction are the antagonists (拮抗肌)

# Quiz\_1

Are skeletal muscles an organ?

(A) Yes

(B) No



<https://forms.gle/TNUECzDiAT63n9wAA>

# Quiz\_2

Are muscle fibers connective tissues?

(A) Yes

(B) No



<https://forms.gle/sBH5FkTYWUvCUicK8>

# Architecture of Skeletal Muscle

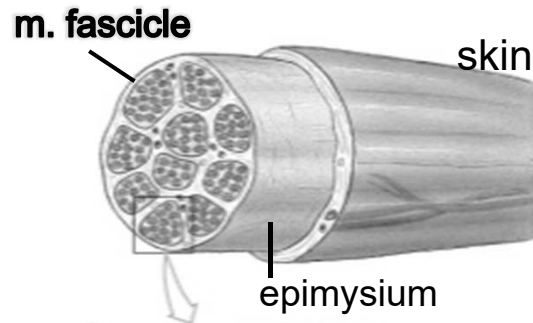

## Level 1: Skeletal Muscle (organ)

- Surrounded by connective tissue epimysium (肌外膜)
- Composed of many muscle fascicles (肌束)

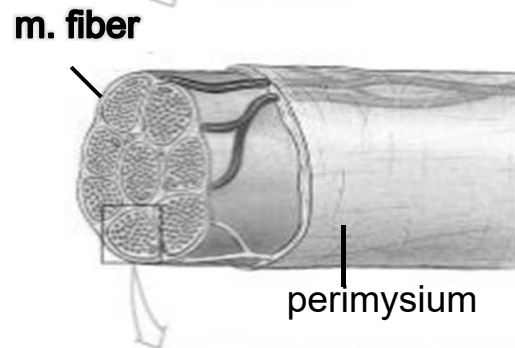

## Level 2: Muscle Fascicle (bundle of cells)

- Surrounded by connective tissue perimysium (肌束膜)
- Composed of many muscle fibers (cells)

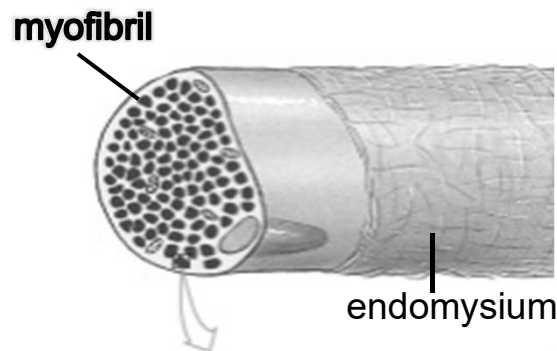

## Level 3: Muscle Fiber (cell; myofiber; myocyte)

- Surrounded by connective tissue endomysium (肌内膜)
- Composed of many myofibrils (肌原纖維)

# Architecture of Skeletal Muscle

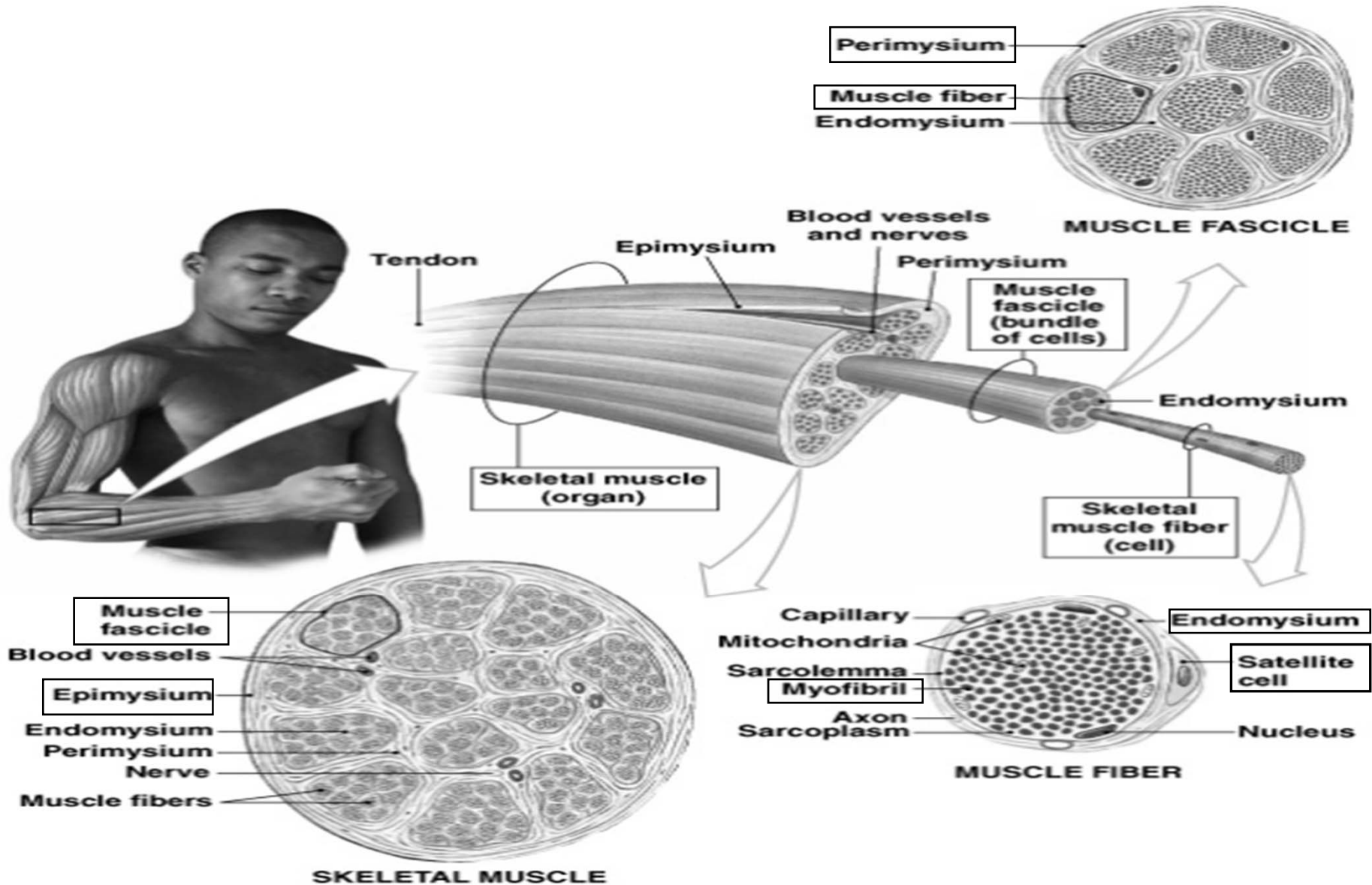



# Architecture of Skeletal Muscle

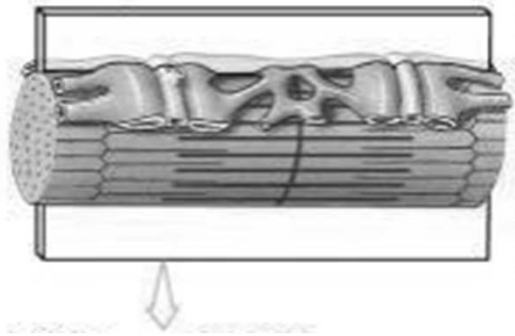

## Level 4: Myofibril (myofilament)

- Surrounded by sarcoplasmic reticulum
- Composed of sarcomeres (肌小節)

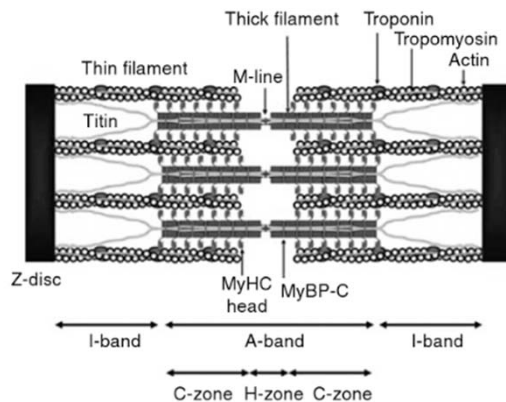

## Level 5: Sarcomere

- Contractile or functional unit of muscle
- Composed of thick (myosin, 肌凝蛋白) & thin (actin, 肌動蛋白) filaments

# Structure of Skeletal Myofiber<sub>1</sub>

Myofiber (myocyte): a muscle cell surrounded by endomysium

- Myofibril: muscle filaments (thick & thin filaments) in the muscle cell
- Sarcolemma: the plasma membrane of a muscle cell
  - Endomysium: a connective tissue that bounds around the sarcolemma
- Sarcoplasm: the cytoplasm of the muscle cell
- Sarcoplasmic reticulum: the endoplasmic reticulum of a muscle cell

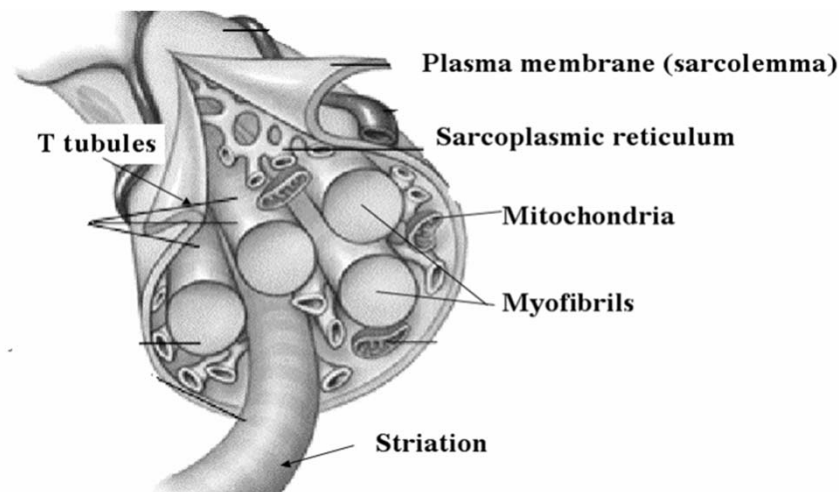

# Structure of Skeletal Myofiber<sub>2</sub>

- T tubule (Transverse tube, 橫管): run perpendicular to and extend from reticulum to outside
  - Have same properties as sarcolemma
  - Transmit action potential through cell
  - Allow entire muscle fiber to contract simultaneously

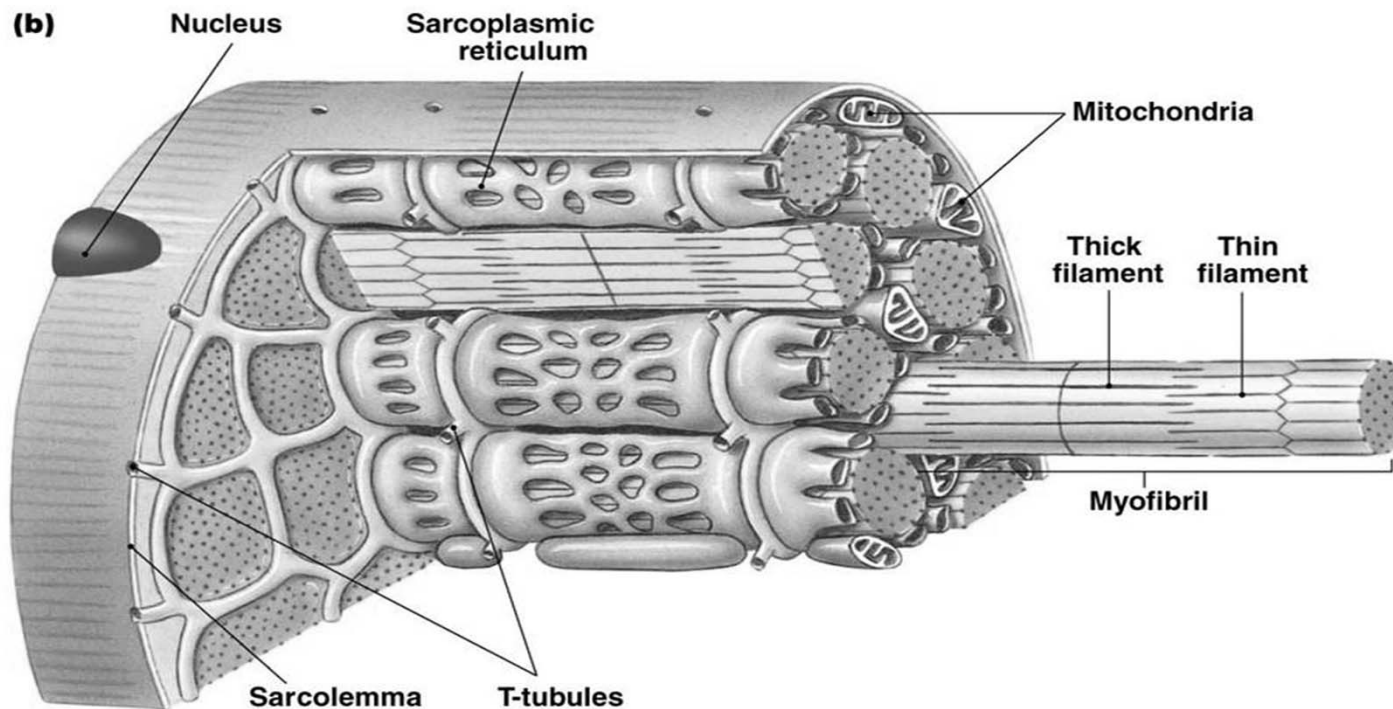

# Structure of Skeletal Myofiber<sub>3</sub>

- Cisterna (池)
  - Concentrate  $\text{Ca}^{2+}$  (*via* ion pumps)
  - Release  $\text{Ca}^{2+}$  into sarcomeres to begin m. contraction
- Triad: formed by 1 T tubule & 2 terminal cisternae
  - A transverse tubule and segments of sarcoplasmic reticulum on either side

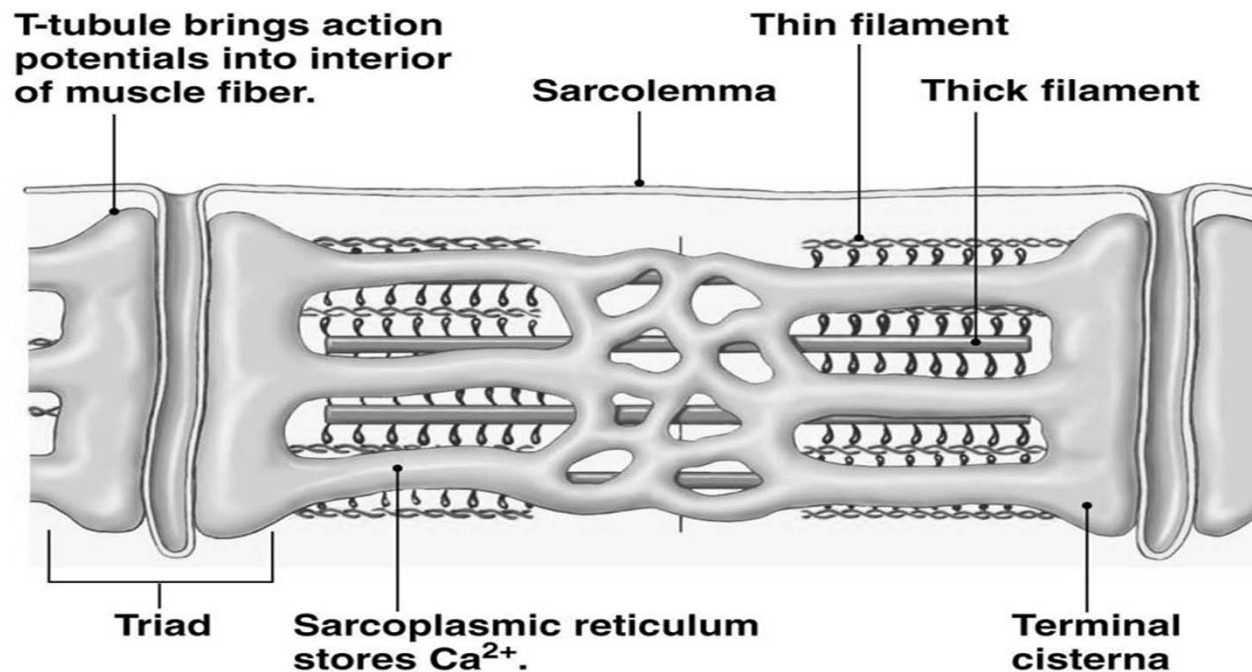

# Architecture of Skeletal Muscle

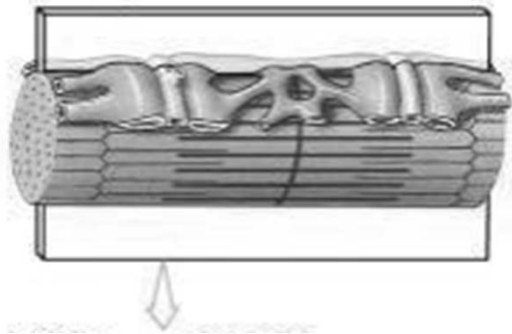

## Level 4: Myofibril (myofilament)

- Surrounded by sarcoplasmic reticulum
- Composed of sarcomeres

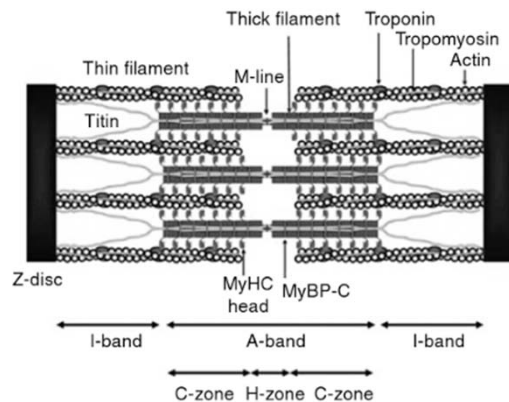

## Level 5: Sarcomere

- Contractile or functional unit of muscle
- Composed of thick (myosin) & thin (actin) filaments

# Thick Filament<sub>1</sub>

- The thick filament system is composed of myosin protein
  - 6 polypeptides: 2 heavy chains, 4 light chains
  - Myosin heavy chains
    - Tail: binds to other myosin molecules
    - Head (crossbridge): made of 2 globular protein subunits & reaches the nearest thin filament

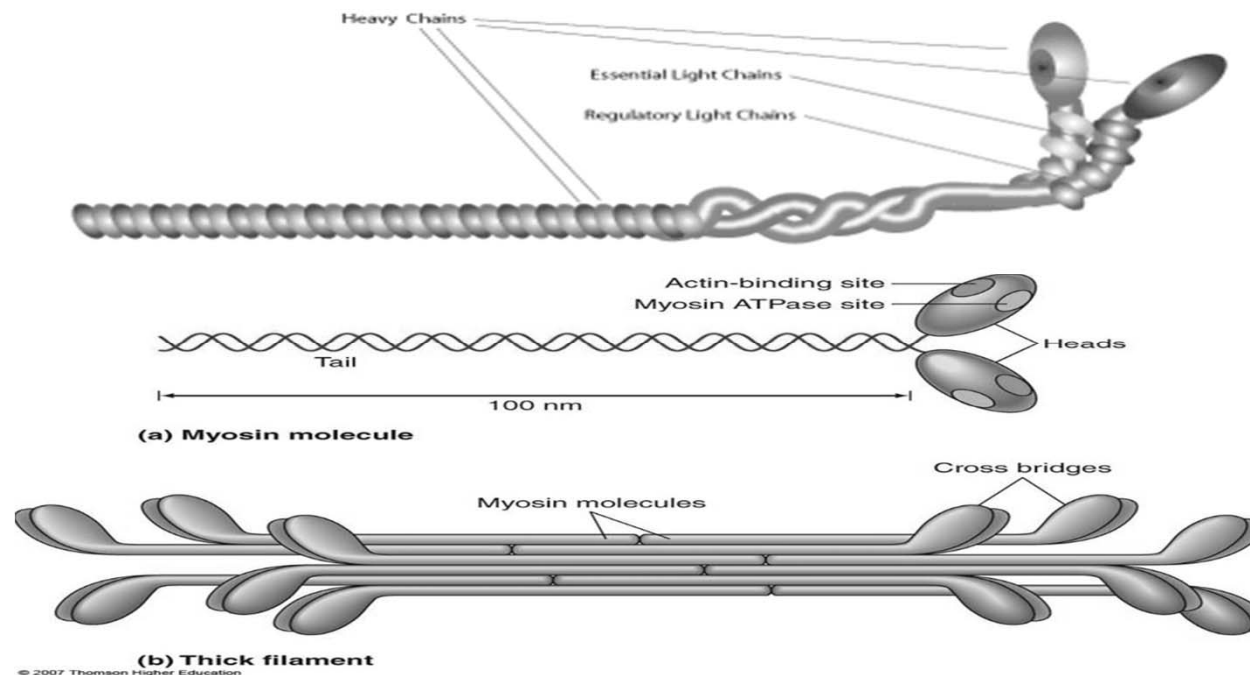

# Thick Filament<sub>2</sub>

- Myosin heavy chains
  - Head (crossbridge):
    - Actin-binding site
    - Myosin ATPase site: molecular motors
      - Use ATP as a source of energy and convert ATP hydrolysis into a physical force
  - Tail: central bare zone

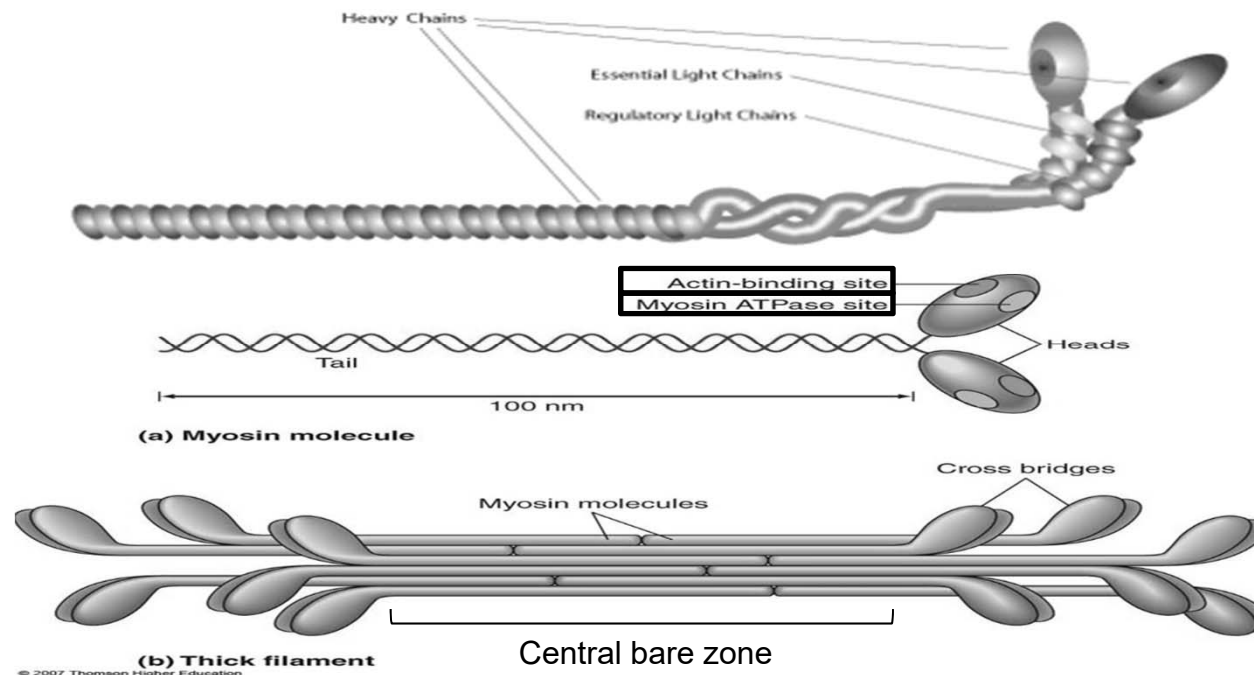

# Quiz\_3

Do thick filaments connect to  
Z-line?

(A) Yes

(B) No



<https://forms.gle/C9qWdE16Gmzajo6p8>



# Thick Filament<sub>3</sub>

- Connected from the M-line to the Z-line by Titin that recoil after stretching

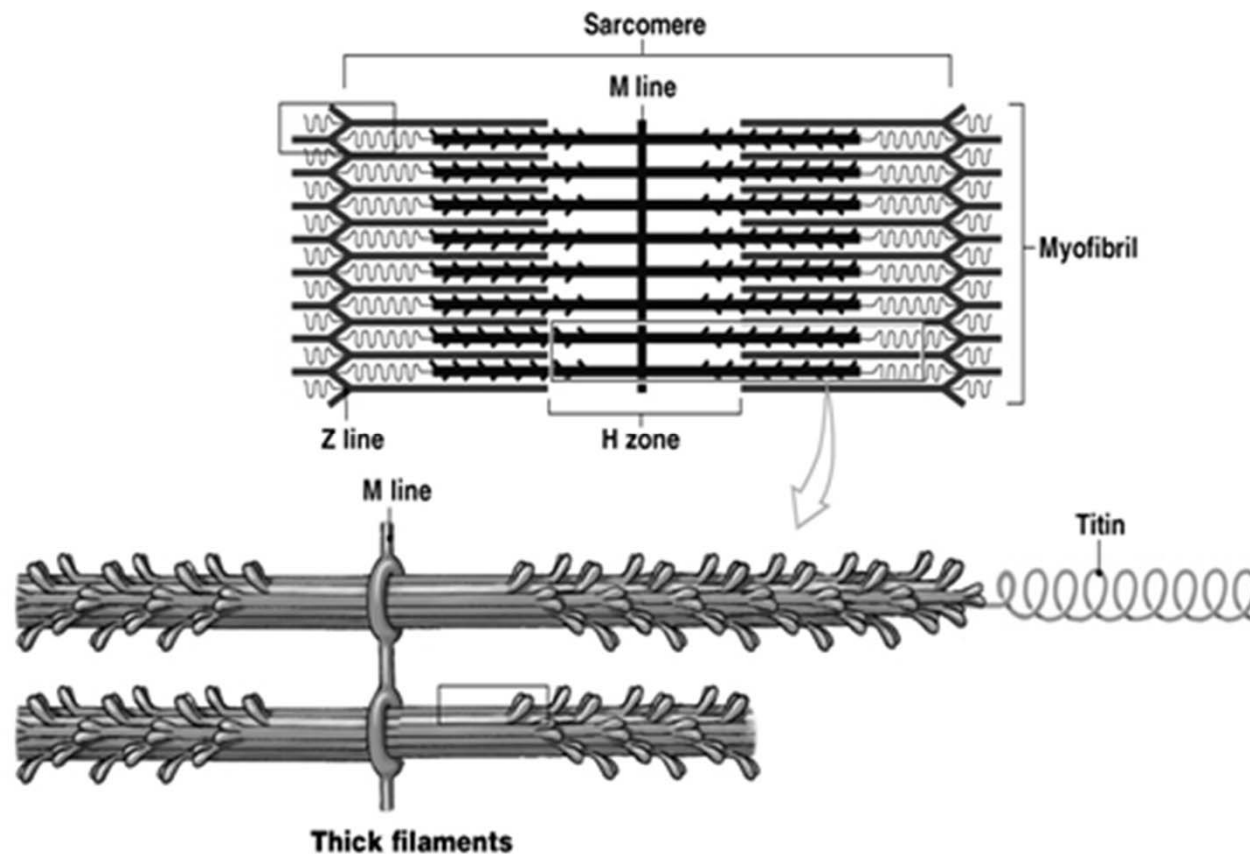

# Thin Filament<sub>1</sub>

Thin filaments contain 4 proteins: actin (肌動蛋白), nebulin, tropomyosin (原肌凝蛋白), & troponin (肌鈣蛋白)

- Actin:
  - Globular actin (G-actin): individual subunits of actin
  - F-actin: G-actin subunits assemble into long filamentous polymers
- Nebulin - holds F actin strands together
- Tropomyosin: a dimer which coils itself around the F-actin of the thin filament

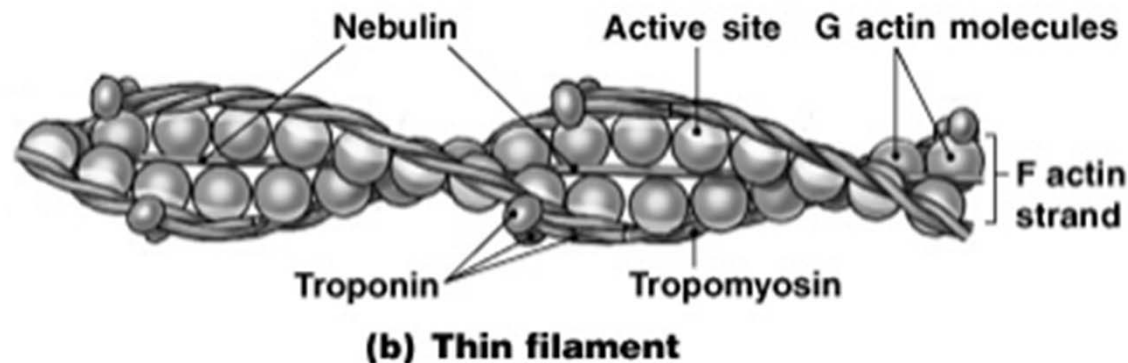

# Thin Filament<sub>2</sub>

- Troponin: a complex of 3 proteins (TnC, TnI, and TnT) that is integral to m. contraction in skeletal and cardiac muscle, but NOT in smooth muscle
  - Troponin C (TnC, calcium) binds to  $\text{Ca}^{2+}$  to produce a conformational change in TnI
  - Troponin I (TnI, inhibition) binds to actin in thin filaments to hold the troponin-tropomyosin complex in place
  - Troponin T (TnT, tropomyosin) binds to tropomyosin, interlocking them to form a troponin-tropomyosin complex

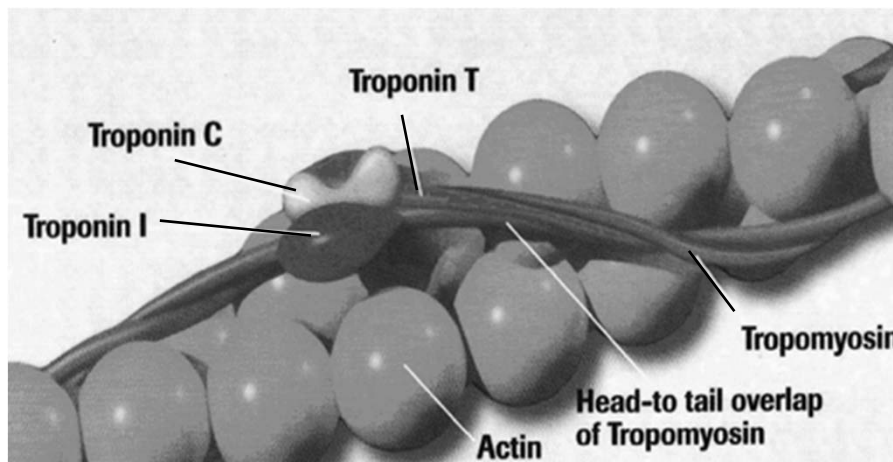

Acute myocardial infarction (AMI) → Hypoxia → cell death → cardiac TnI or TnT released in blood

# Structure of Sarcomere<sub>1</sub>

- Sarcomere: basic contractile unit of a striated myofibril
  - Between Z lines
- Striation pattern (in skeletal and cardiac muscle)
  - Z line (disk): connects adjacent sarcomeres & anchors thin filaments
  - I band: composed of thin filaments only
    - Across two sarcomeres

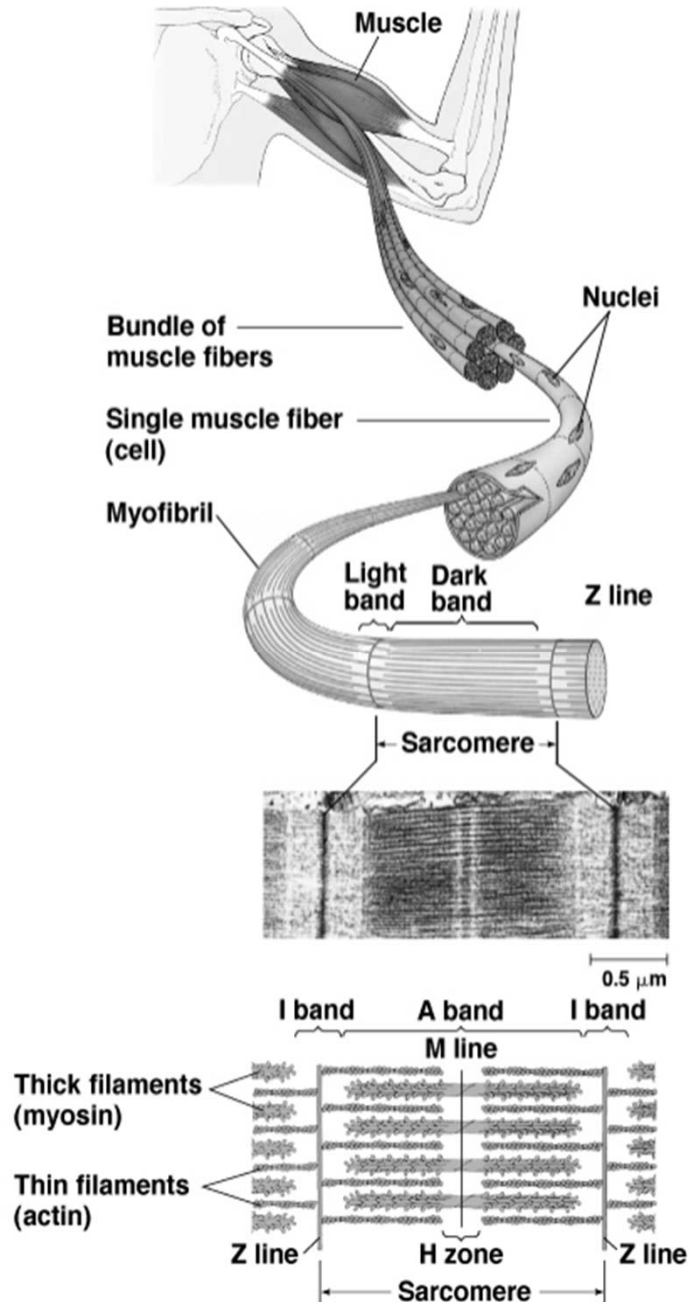

# Structure of Sarcomere<sub>2</sub>

- Striation pattern (in skeletal and cardiac muscle)
  - A band: composed of thick and overlapping thin filaments
    - Each sarcomere has **TWO T tubules** at the junction of A band and I band
  - H zone: a paler region within the A-band & composed of thick filaments only
  - M line: inside the H-band (middle of the sarcomere); central bare zone
  - C zone: overlapped area between thick (cross bridge) and thin filaments

Length of thick filament?

→ A band width

or (Sarcomere – I band)

Length of thin filament?

→ (Sarcomere – H zone) / 2

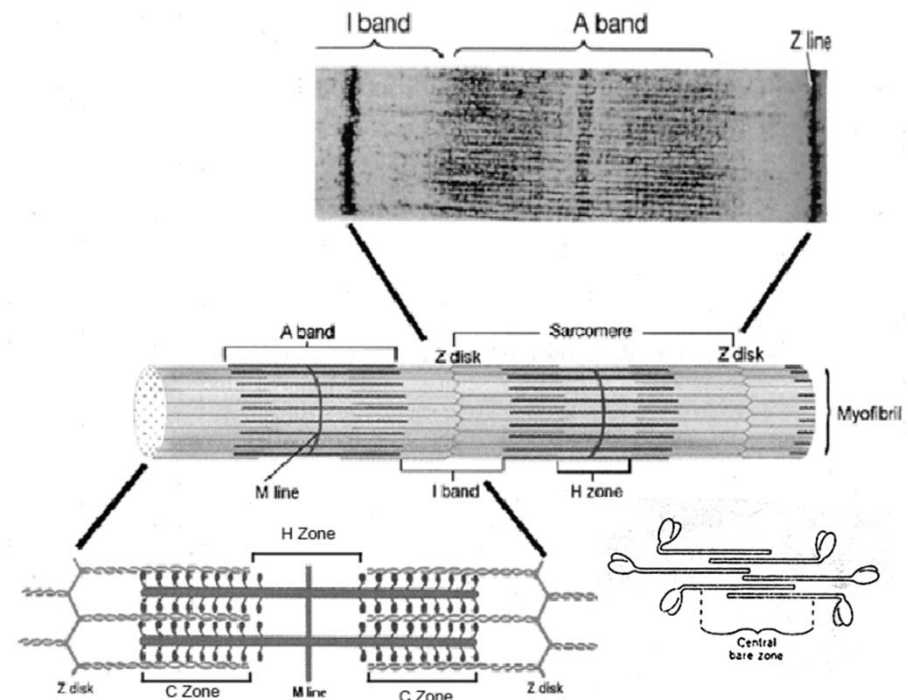

# Quiz\_4

If we did cross-section of skeletal muscles, which area can be seen the thick filaments only:

- (A) H zone
- (B) I band
- (C) C zone
- (D) A band



<https://forms.gle/G64p3bryzq31t8kQ9>

# Quiz\_5

If we did cross-section of skeletal muscles, which area can be seen the thin filaments only:

- (A) H zone
- (B) I band
- (C) C zone
- (D) A band

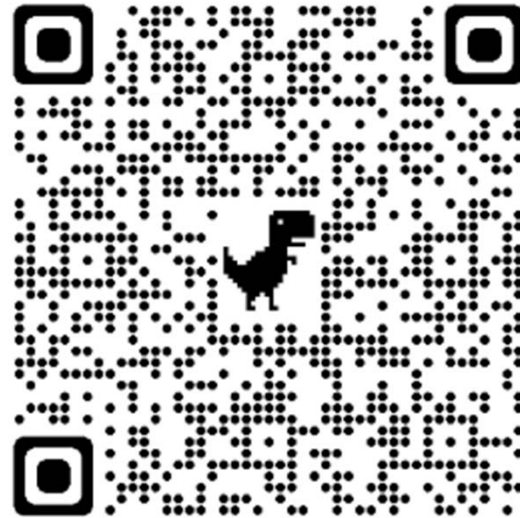

<https://forms.gle/oxezhJ3Ef8f4d2Te6>

# Quiz\_6

If we did cross-section of skeletal muscles, which area can be seen both thick and thin filaments:

- (A) H zone
- (B) I band
- (C) C zone
- (D) A band



<https://forms.gle/6Utx6fjWJZjW5rF28>



# Architecture of Skeletal Muscle

Cross section of myofibril

- Each thick filament is surrounded by 6 thin filaments
- Each thin filament is surrounded by 3 thick filaments

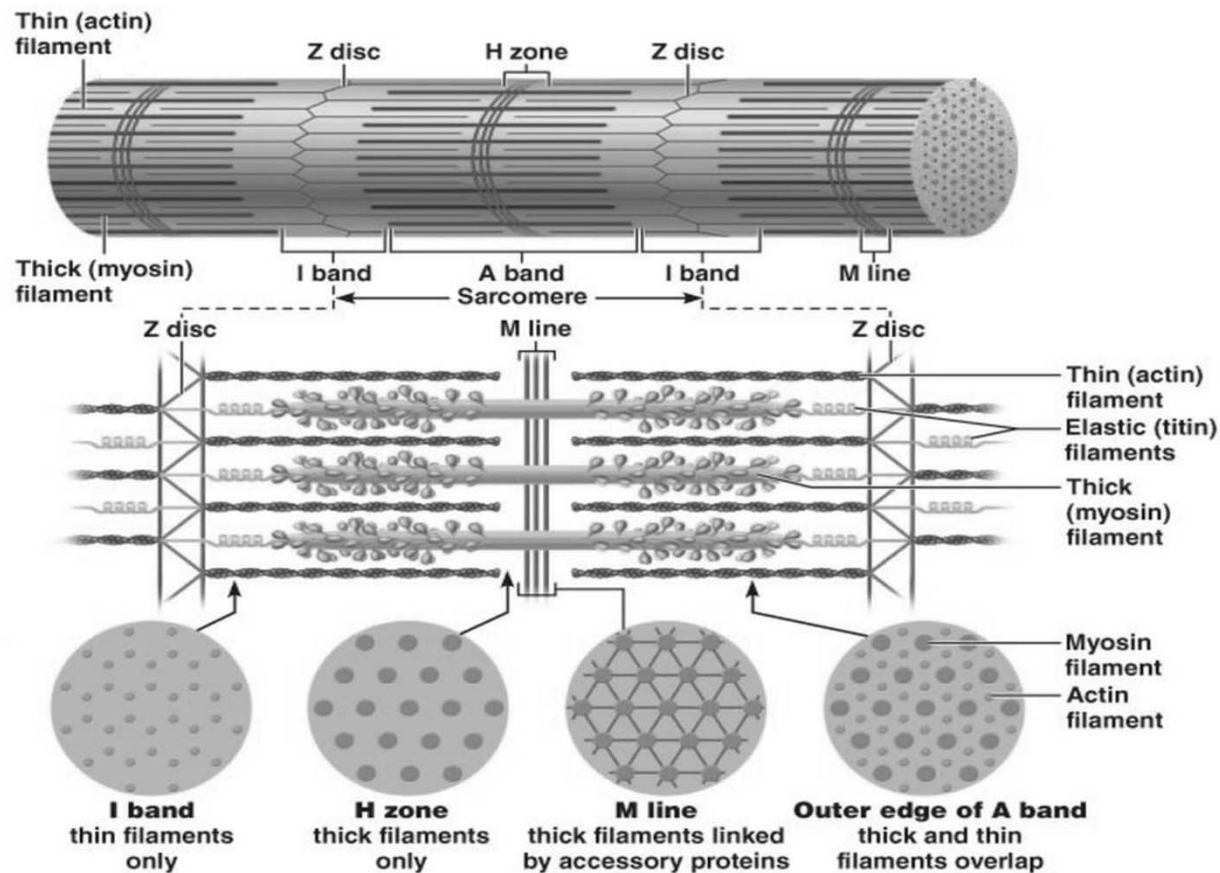

# Architecture of Skeletal Muscle

**Muscle (organ)**

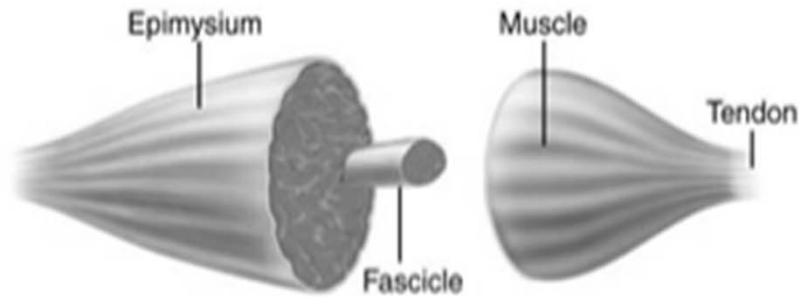

**Fascicle (a portion of the muscle)**

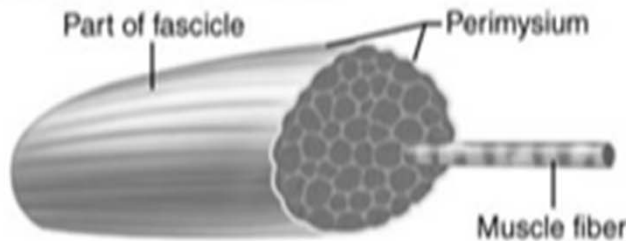

**Muscle Fiber (cell)**

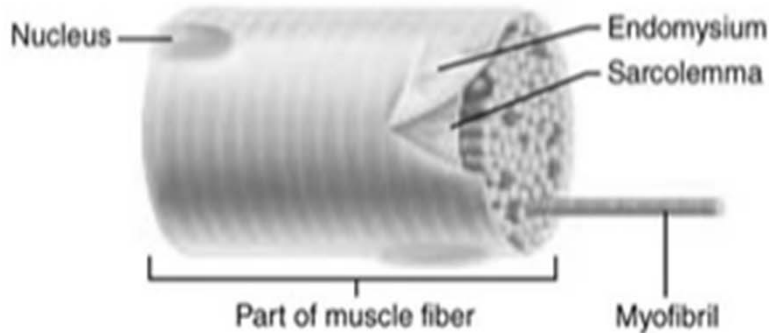

**Myofibril or Fibril (complex organelle composed of bundles of myofilaments)**

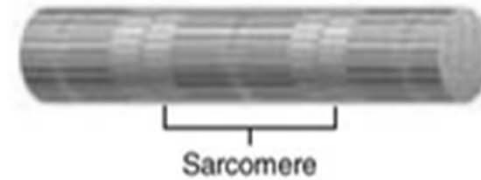

**Sarcomere (a segment of a myofibril)**

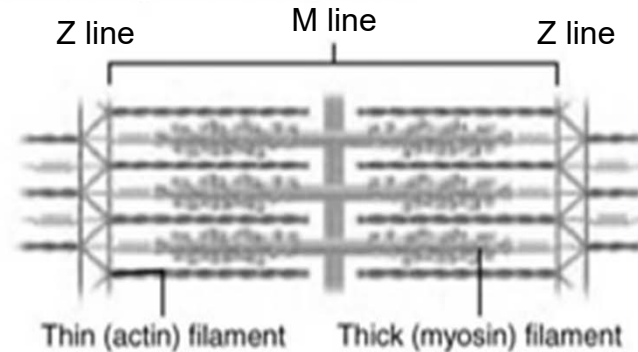

**Myofilament or Filament (extended macromolecular structure)**

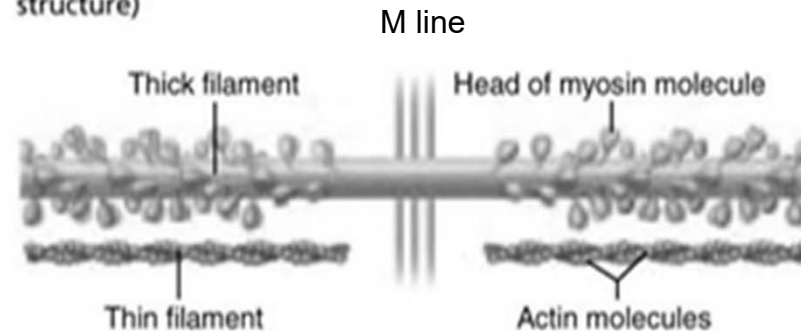

# Sensory Receptors of Skeletal M.

- The Golgi tendon organ is a proprioceptive sensory receptor organ that is located at the insertion of skeletal muscle fibers into the tendons of skeletal muscle
- Muscle spindles (肌梭) are sensory receptors within the belly of a muscle, which primarily detect changes in the length of this muscle

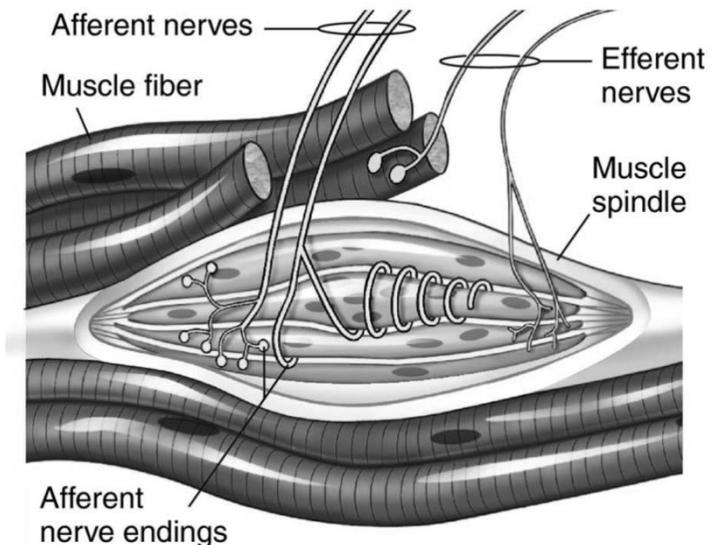
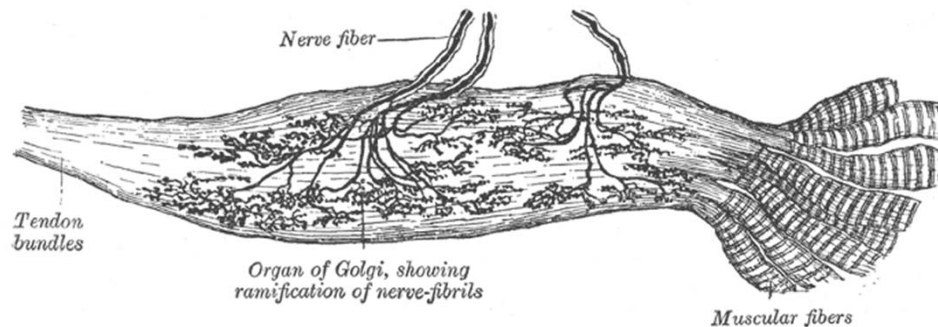

# Structure of M. Spindle

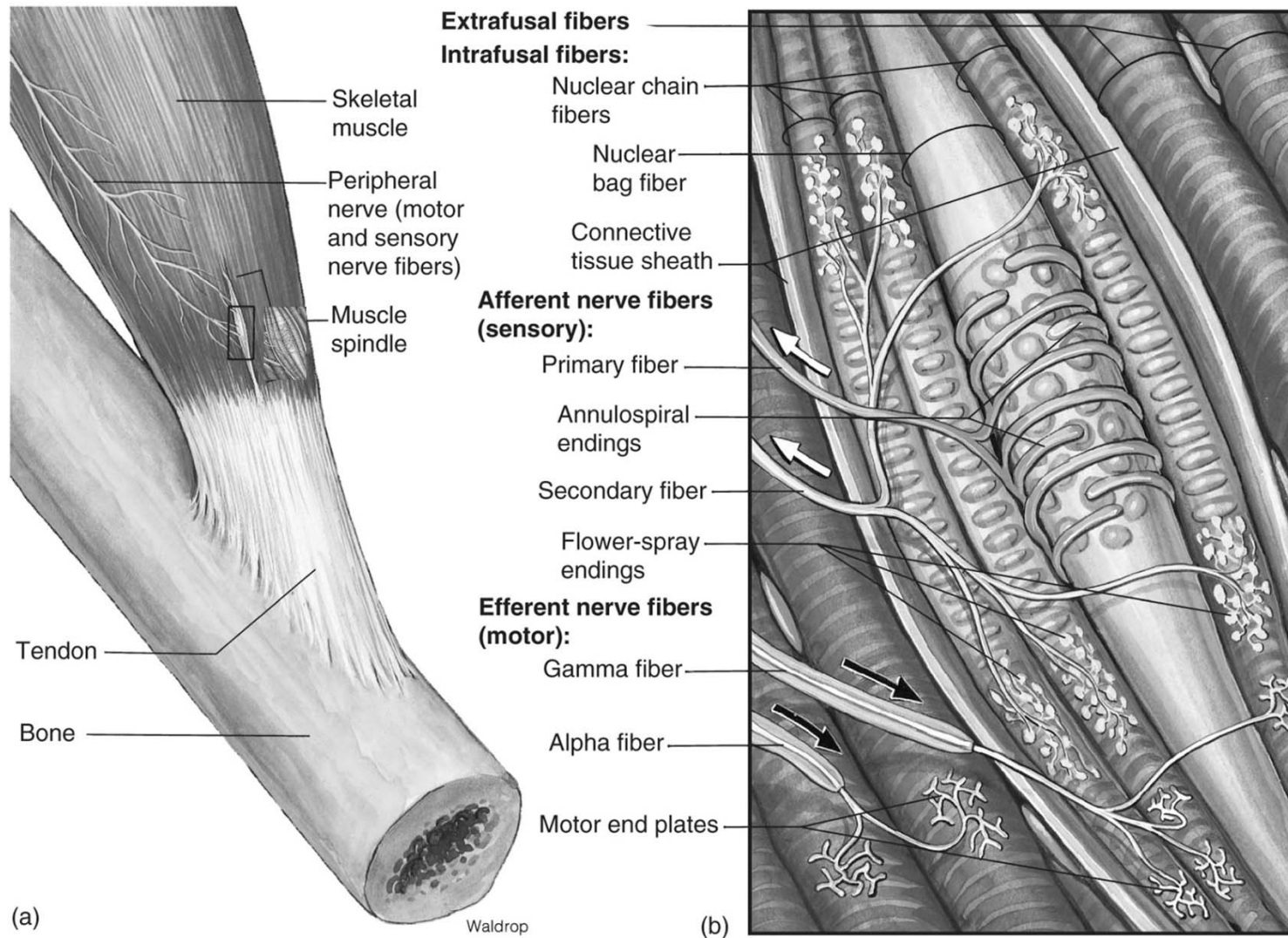

# Structure of M. Spindle

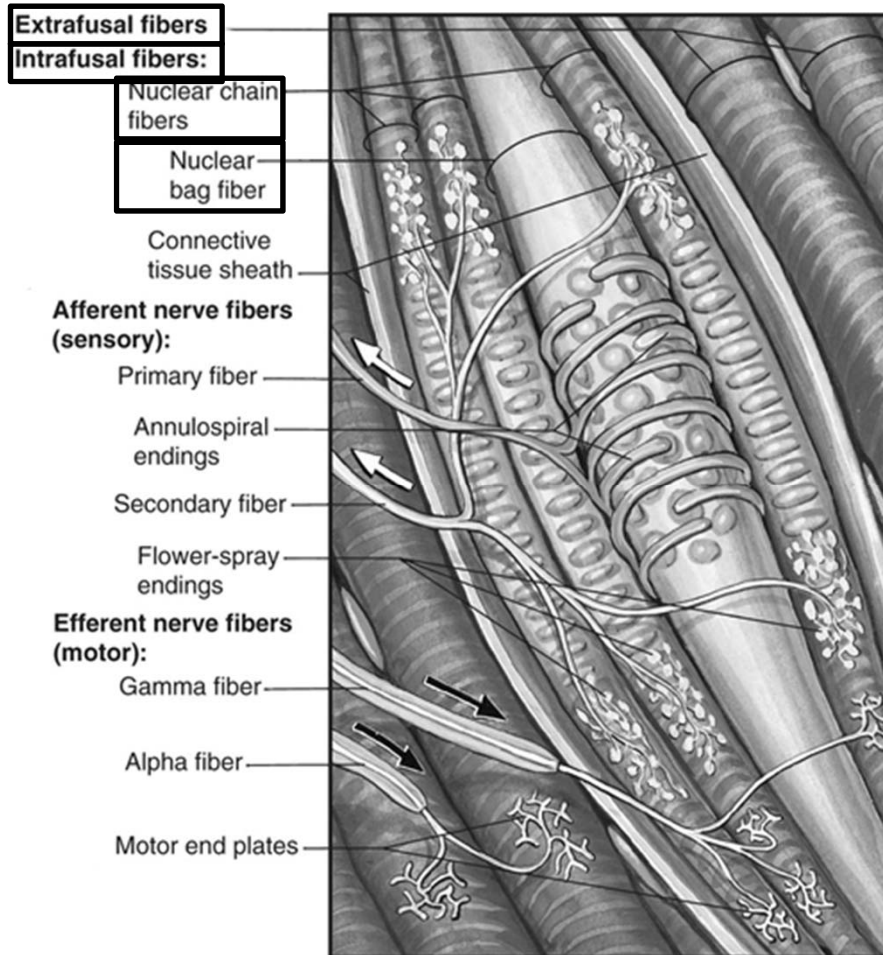

- Extrafusal fiber: m. fibers outside m. spindle
  - Myofibrils along the entire length
- Intrafusal fiber: m. fibers in m. spindle
  - Nuclear bag fiber
  - Nuclear chain fiber
- The contractile apparatus is absent from the central regions (only nuclei)

# Structure of M. Spindle

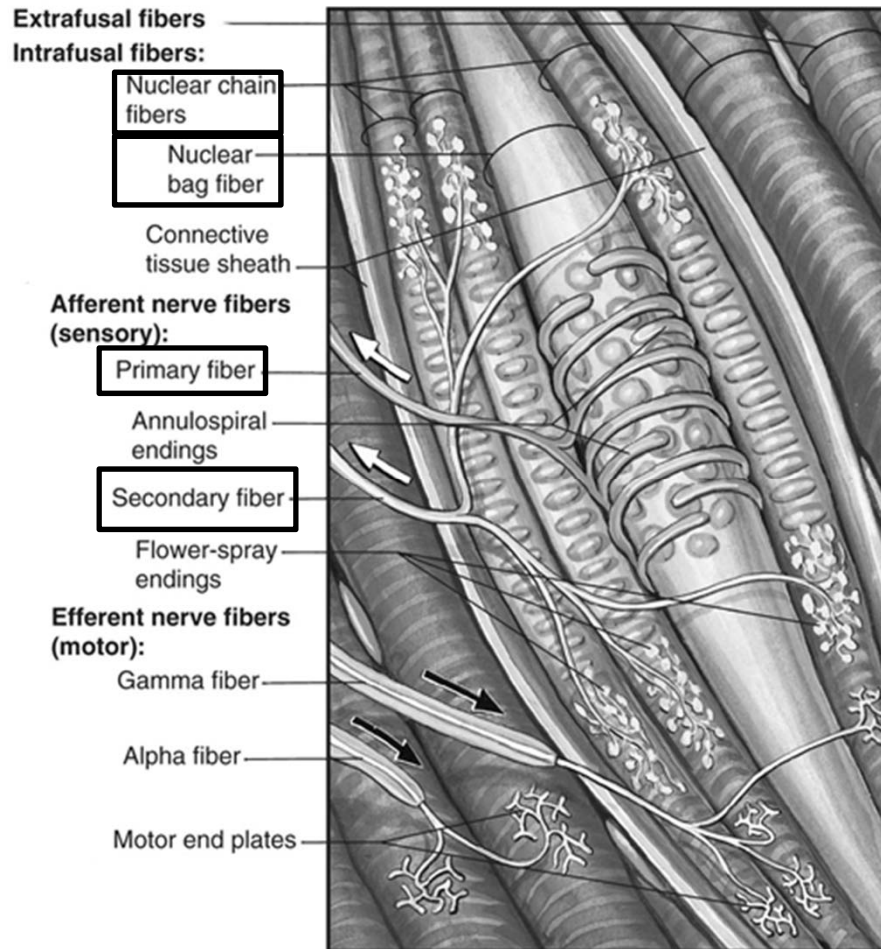

- Afferent (sensory) nerve fibers
  - Primary afferent fiber (Ia fiber)
    - Nuclear bag fiber
    - Nuclear chain fiber
  - Secondary afferent fiber (II fiber)
    - Nuclear chain fiber
- The spindle apparatus serves as a length detector

Length of the muscle  $\uparrow \rightarrow$  frequency of impulses  $\uparrow$  38

# Structure of M. Spindle

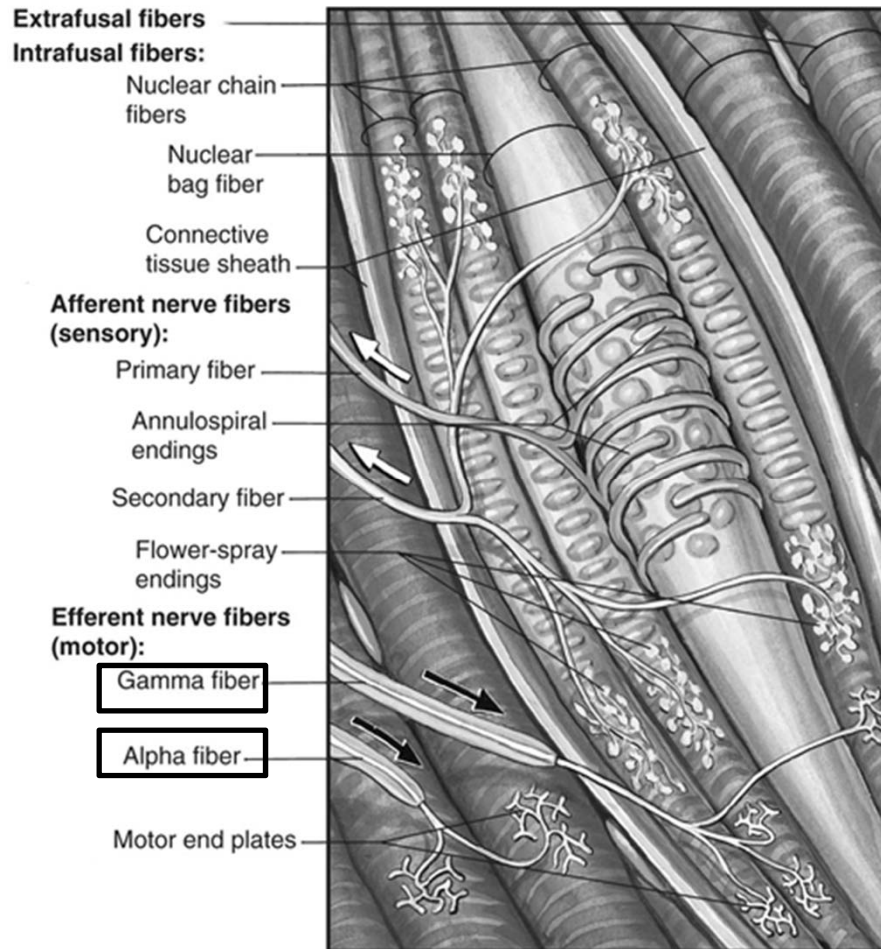

- Efferent (motor) nerve fibers
  - Alpha fiber: innervate extrafusal fiber
  - Gamma fiber: innervate intrafusal fiber
    - Contraction of these fibers does not shorten the muscle
    - But increase sensitivity to stretch

# Quiz\_7

How to maintain the sensitivity of afferent (sensory) nerve during skeletal muscle contraction?

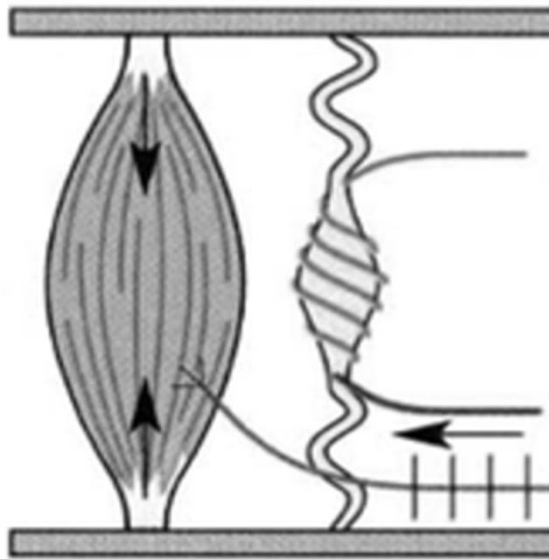

<https://forms.gle/2WbkbxfE6RT3CaJ57>



# Sensitivity Modulation ( $\alpha$ - $\gamma$ Coactivation)

- Contraction of extrafusal fibers (alpha motor neuron)  $\rightarrow$  muscle spindle become slack  $\rightarrow$  sensory n. stop transmitting impulses
- Contraction of extrafusal fibers + intrafusal fibers (gamma motor neuron)  $\rightarrow$  sensitivity of muscle spindle maintains

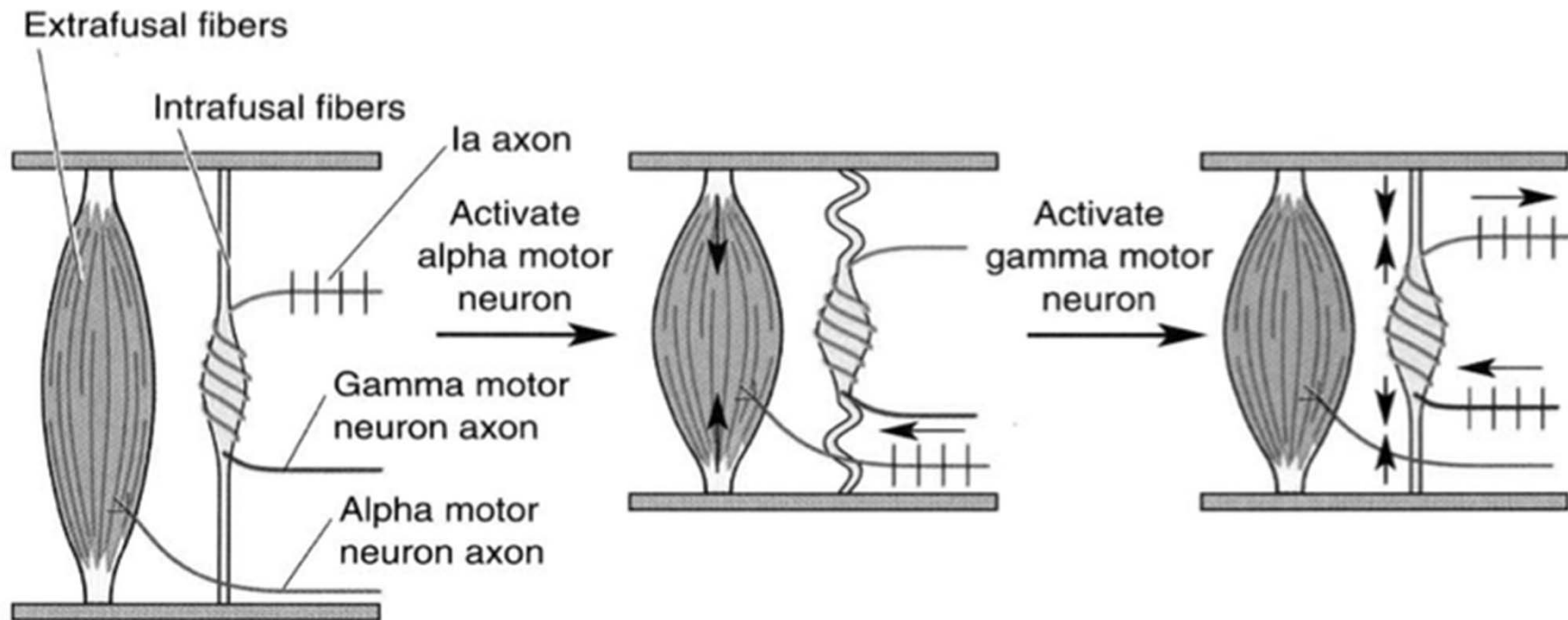

# Skeletal Muscle Repair

- Skeletal muscles have stem cells, called satellite cells, located near muscle fibers
  - These can fuse to damaged muscle cells and repair them or fuse to each other to form new muscle fibers
- Myostatin is a paracrine regulator that inhibits satellite cells

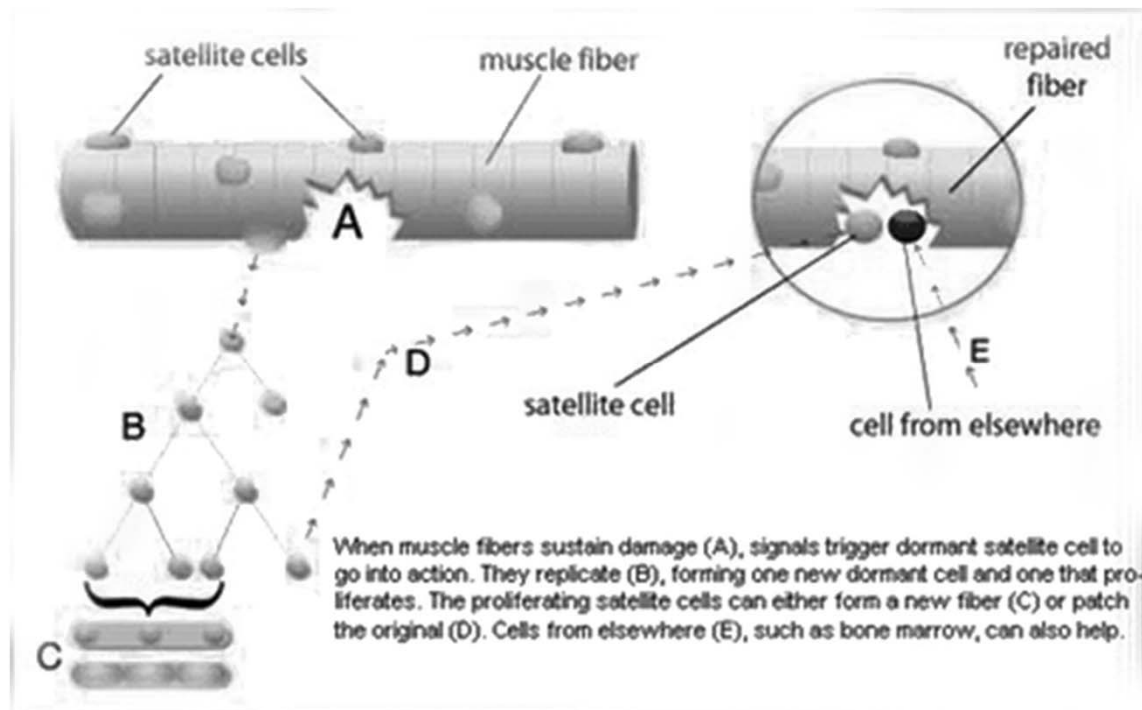

# Architecture of Skeletal Muscle

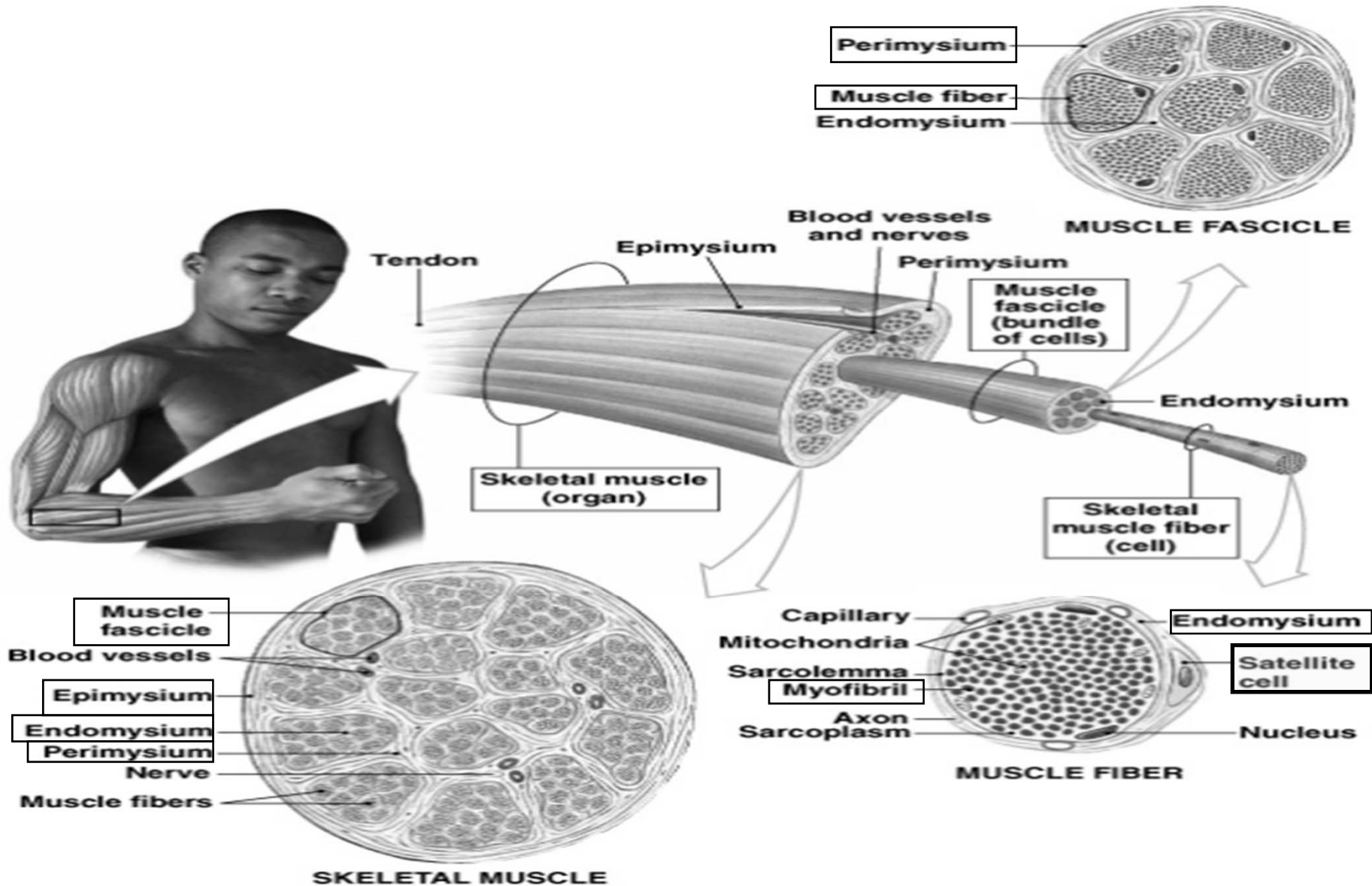

# Outlines

1. Background
2. Skeletal Muscle
  - Architecture & Structure
  - Sliding Filament Model of M. Contraction
  - Process of Skeletal M. Contraction
  - Control of Skeletal M. Contraction
  - Mechanics of Skeletal M. Contraction
  - Energetics of Skeletal M. Contraction
3. Smooth Muscle
  - Structural Characteristics
  - Smooth Muscle Contraction & Relaxation
  - Classification of Smooth Muscle
4. Cardiac Muscle

# Sliding Filaments

As a muscle shortens, the following is observed:

- Sarcomeres shorten
- I band length becomes shorten
- H zone reduced
- Myofilament length remains constant
- A band length remains constant

① Fully relaxed sarcomere of a muscle fiber    ② Fully contracted sarcomere of a muscle fiber

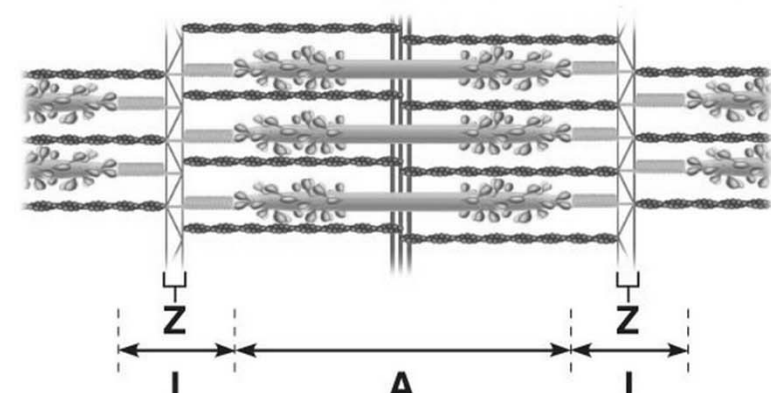
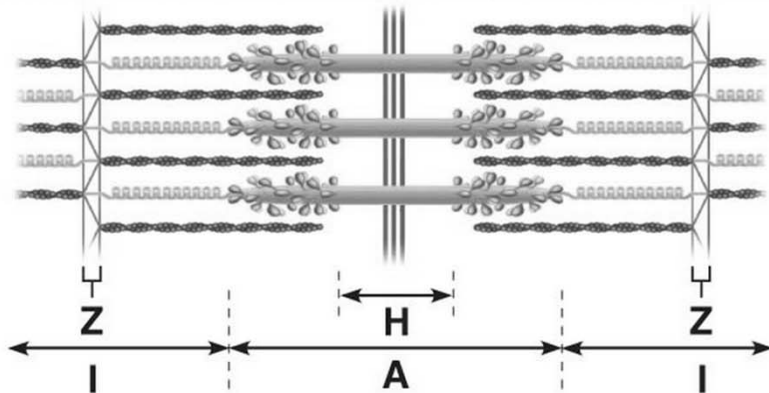
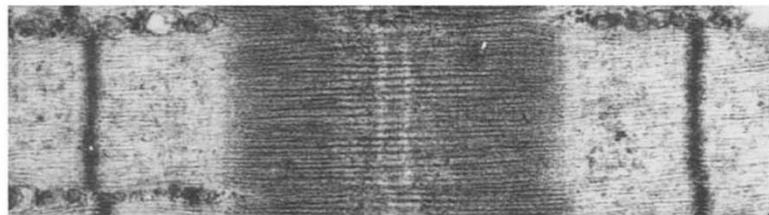

# Sliding Filaments

As a muscle shortens, the following is observed:

- Sarcomeres shorten
- I band length becomes shorten
- H zone reduced
- Myofilament length remains constant
- A band length remains constant

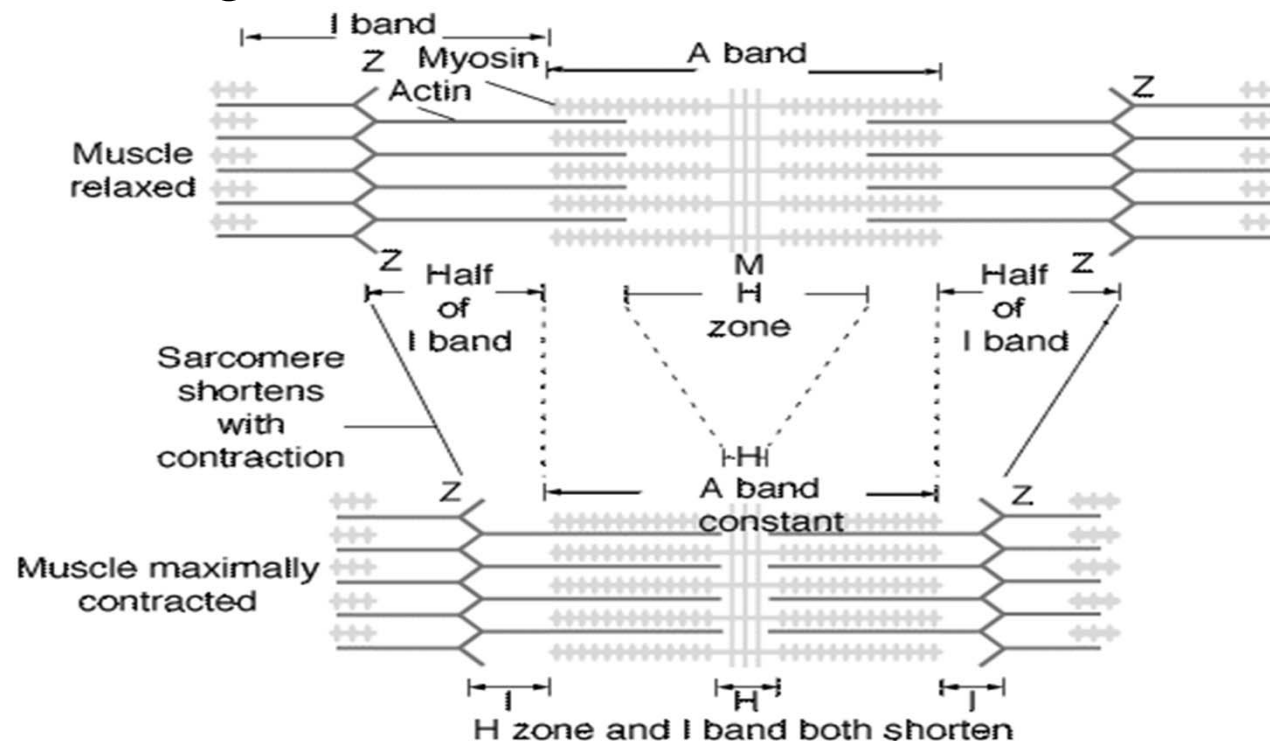

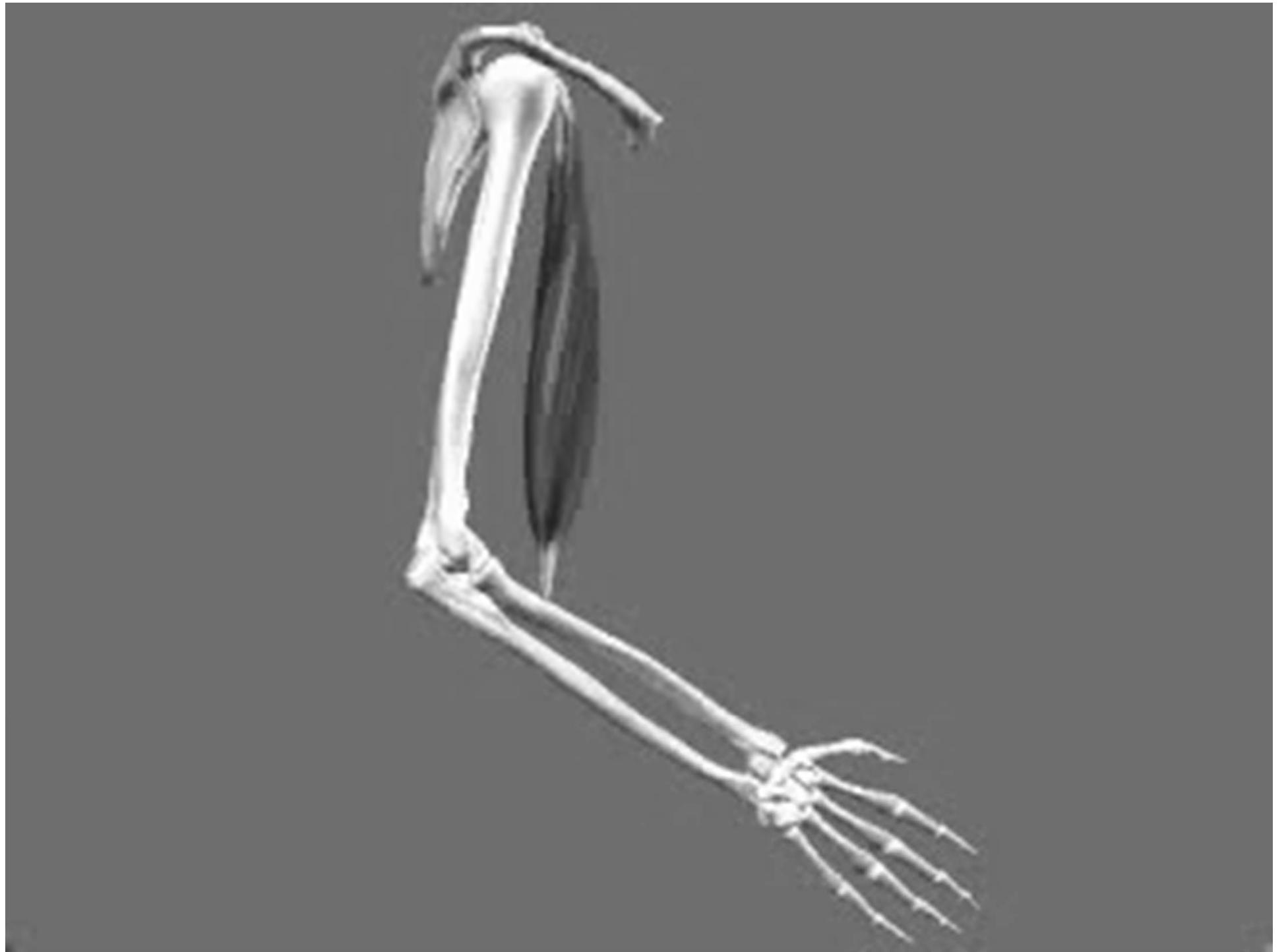

# Example Question\_Q8



<https://forms.gle/AiPDnfer5n1uSwSj6>

Given a muscle length at rest as following:

\*A band =  $1.5 \mu\text{m}$     \*I band =  $1.0 \mu\text{m}$     \*H zone =  $0.7 \mu\text{m}$

During contraction, the muscle shortens by 20%. What is the length of the...

- a) Sarcomere
- b) Thick filament
- c) Thin filament
- d) A band
- e) I band
- f) H zone
- g) Overlap between thick and thin filaments (C zone) (total area)

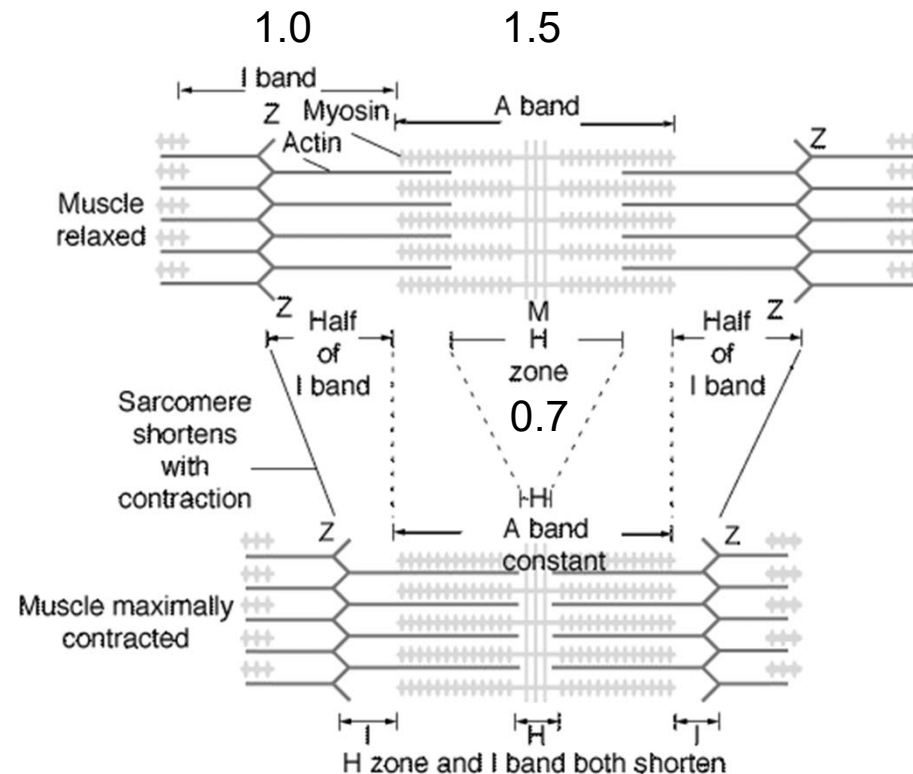



# Example Question

Given a muscle length at rest as following:

\*A band = 1.5  $\mu\text{m}$     \*I band = 1.0  $\mu\text{m}$     \*H zone = 0.7  $\mu\text{m}$

During contraction, the muscle shortens by 20%. What is the length of the...

a) Sarcomere

$$(1.5 + 1) \times 0.8 = 2.0 \mu\text{m}$$

b) Thick filament

$$1.5 \mu\text{m} \text{ (no change!)}$$

c) Thin filament

$$(2.5 - 0.7) / 2 = 0.9 \mu\text{m} \text{ (no change!)}$$

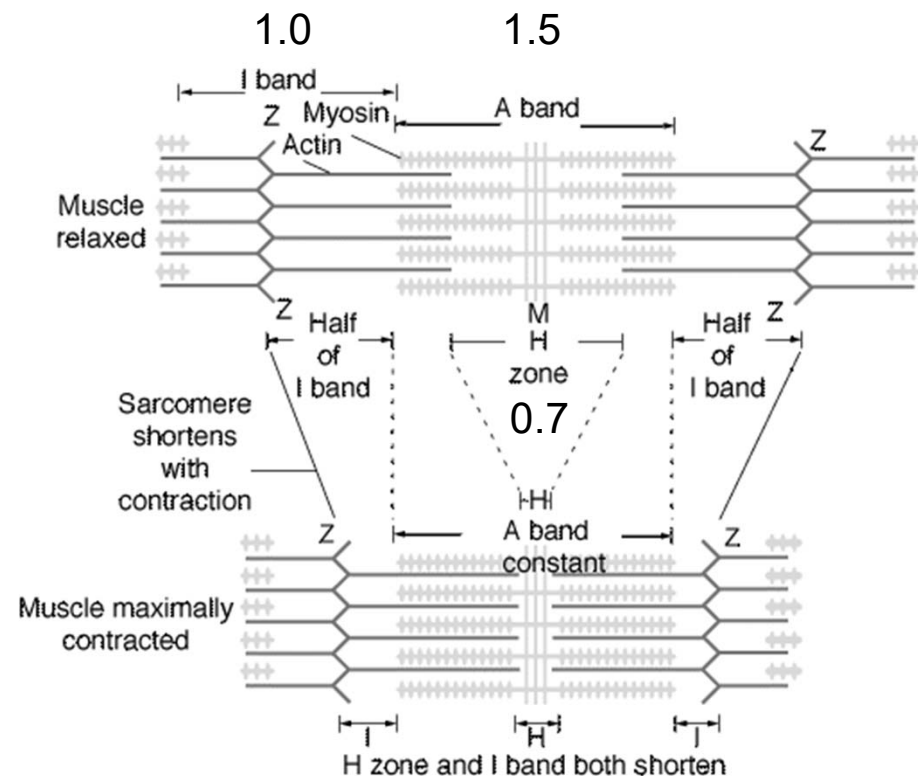

# Example Question

Given a muscle length at rest as following:

\*A band = 1.5  $\mu\text{m}$     \*I band = 1.0  $\mu\text{m}$     \*H zone = 0.7  $\mu\text{m}$

During contraction, the muscle shortens by 20%. What is the length of the...

d) A band

1.5  $\mu\text{m}$  (no change!)

e) I band

$2.0 - 1.5 = 0.5 \mu\text{m}$

f) H zone

$2.0 - (2 \times 0.9) = 0.2 \mu\text{m}$

g) Overlap between thick and thin filaments (C zones)

$1.5 - 0.2 = 1.3 \mu\text{m}$

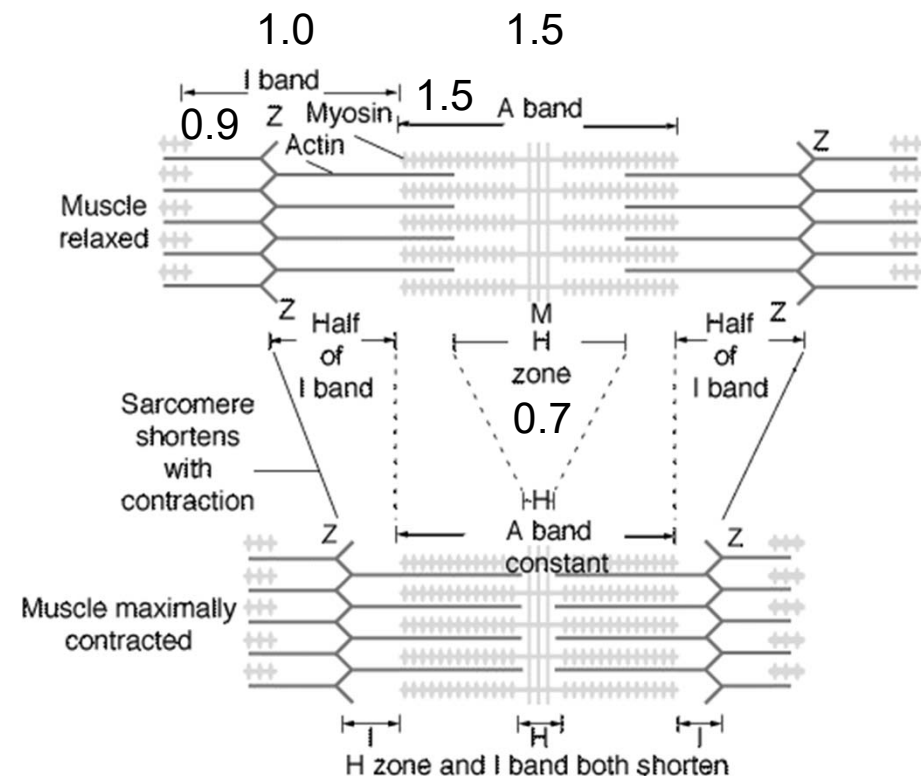

# Outlines

1. Background
2. Skeletal Muscle
  - Architecture & Structure
  - Sliding Filament Model of M. Contraction
  - Process of Skeletal M. Contraction
  - Control of Skeletal M. Contraction
  - Mechanics of Skeletal M. Contraction
  - Energetics of Skeletal M. Contraction
3. Smooth Muscle
  - Structural Characteristics
  - Smooth Muscle Contraction & Relaxation
  - Classification of Smooth Muscle
4. Cardiac Muscle



When an action potential travels to a muscle fiber,



*Icecream*  
APPS

# Phases of M. Contraction

Three phases of m. contraction (twitch):

1. Latent period
2. Period of contraction
3. Period of relaxation

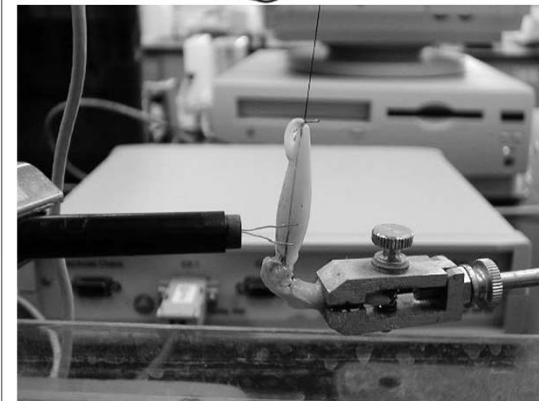
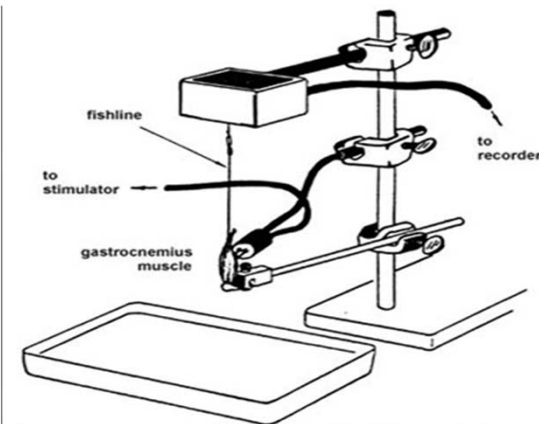
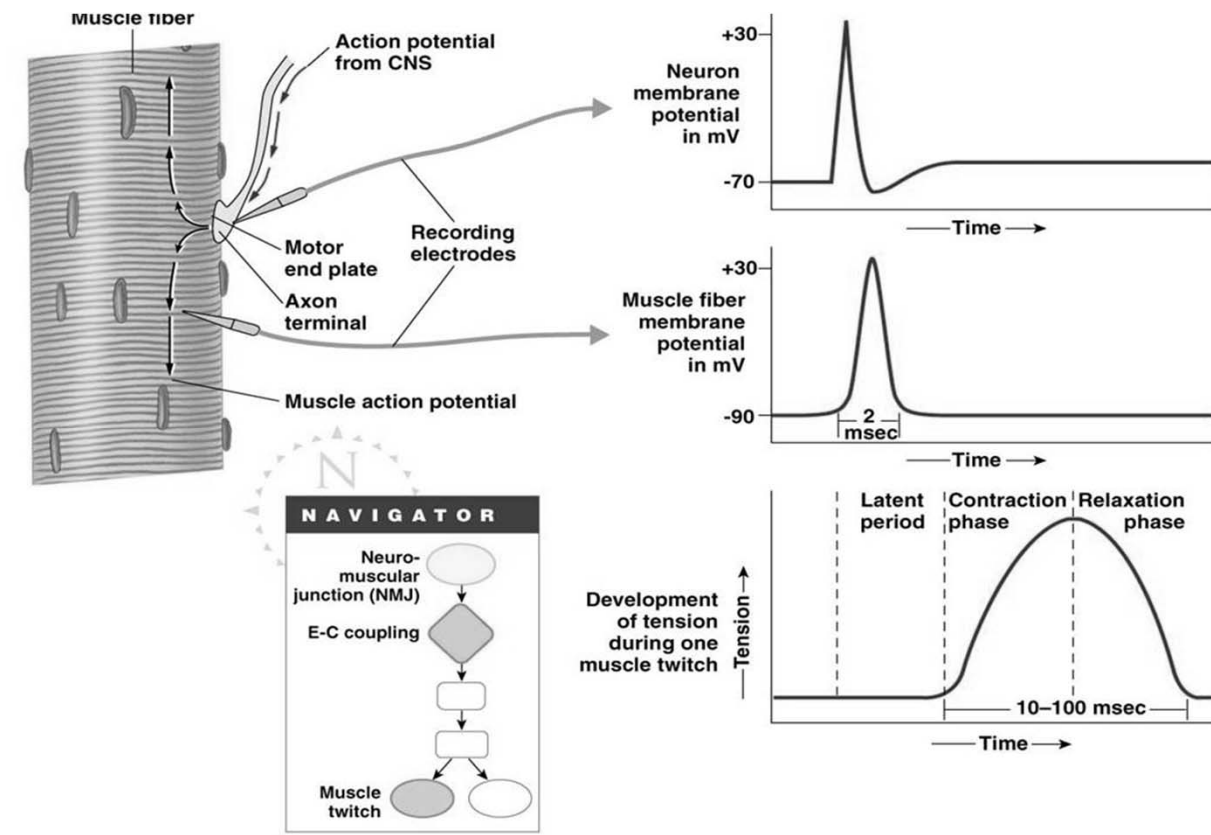



# Process of Skeletal Muscle Contraction

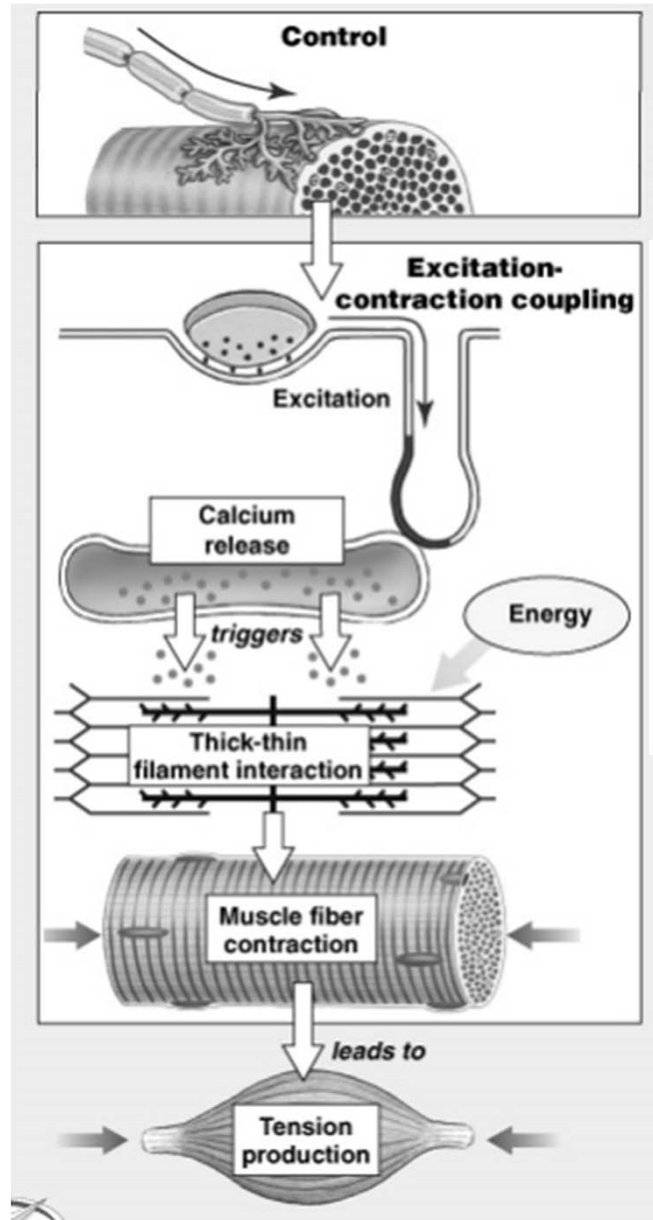

## Phase 1: Motor neuron stimulates muscle fiber

- (1) Discharge of motor neuron.
- (2) Release of transmitter (acetylcholine) at motor end-plate.
- (3) Binding of acetylcholine to nicotinic acetylcholine receptors.
- (4) Increased  $\text{Na}^+$  and  $\text{K}^+$  conductance in end-plate membrane.
- (5) Generation of end-plate potential.

# Neuromuscular Junction<sub>1</sub>

- The nerve impulse reaches the neuromuscular junction, which consists of
  - Axonal terminal of a somatic motor neuron
  - Synaptic cleft
  - Motor end plate

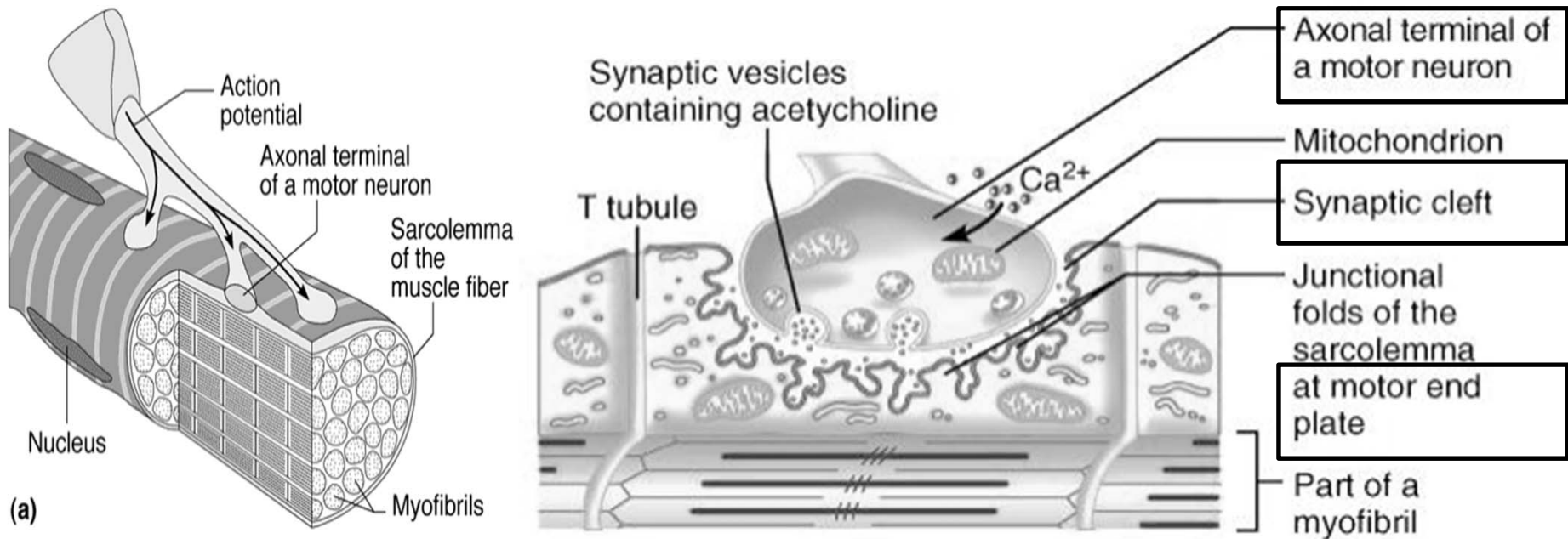



# Neuromuscular Junction<sub>2</sub>

- When an impulse reaches the axonal terminal,  $\text{Ca}^{2+}$  enters voltage-gated channel
- Acetylcholine (Ach) is released from the active zone of motor neuron via exocytosis of synaptic vesicles (quantal release)

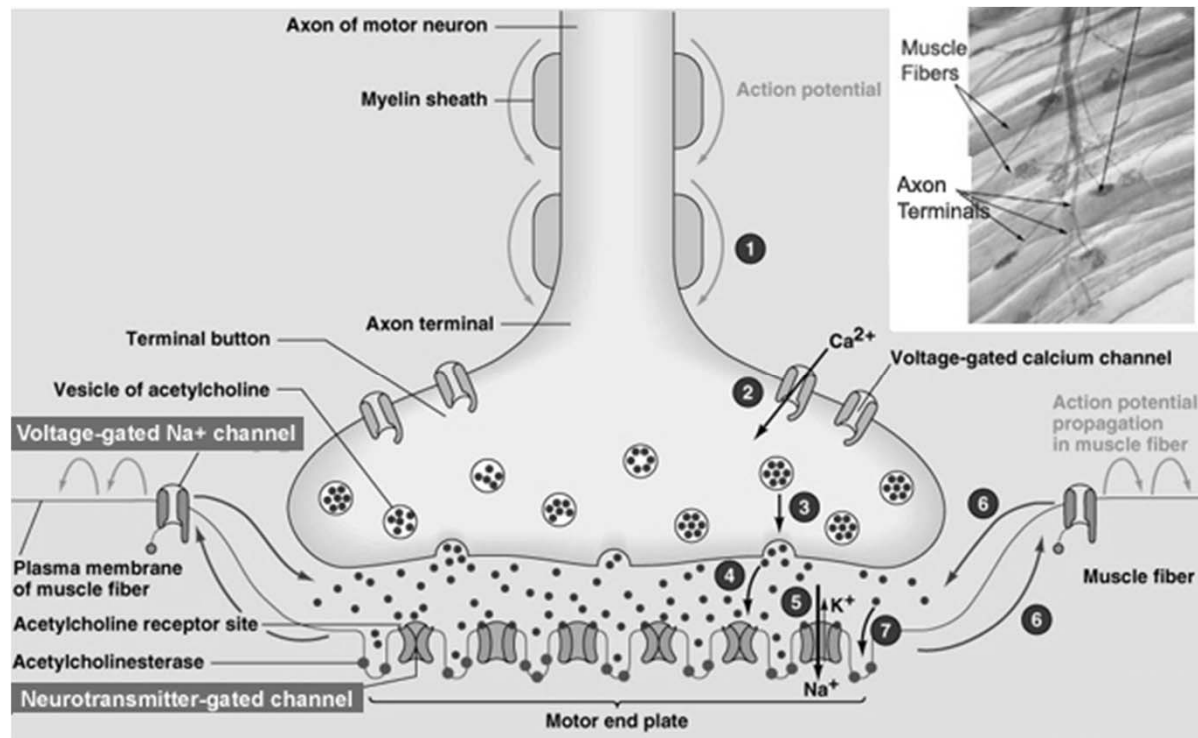

# Quiz\_9

Why injection of Botulinum toxin (肉毒桿菌素) can reduce facial wrinkles?

(A) It inhibits the release of Ach

(B) It stimulates the release of Ach



<https://forms.gle/8a5pBujB5r35k8YC7>

# Cosmetic Aesthetic Medicine

- Botulinum toxin (肉毒桿菌素) can inhibit the release of Ach
- Botulinum toxin injection: wrinkle reduction is noticeable in 3-5 days with full effects being achieved by 2 weeks
- Results last about 3 months

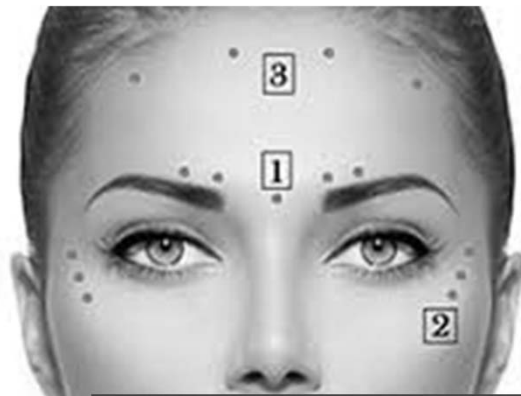

1. Frown Lines
2. Crow's Feet
3. Forehead Lines



# Quiz\_10

What is the purpose of converting electrical signal to chemical signal?

- (A) amplify electrical signal
- (B) reduce electrical signal



<https://forms.gle/tmSnUSdtYYejcnGt7>

# Neuromuscular Junction<sub>3</sub>

- Motor neurons communicate with skeletal m. fiber through the neurotransmitter acetylcholine (Ach) → amplify signal
- Ach is synthesized from acetyl-coenzyme A and choline, and stored in synaptic vesicles at the distal end of the axon

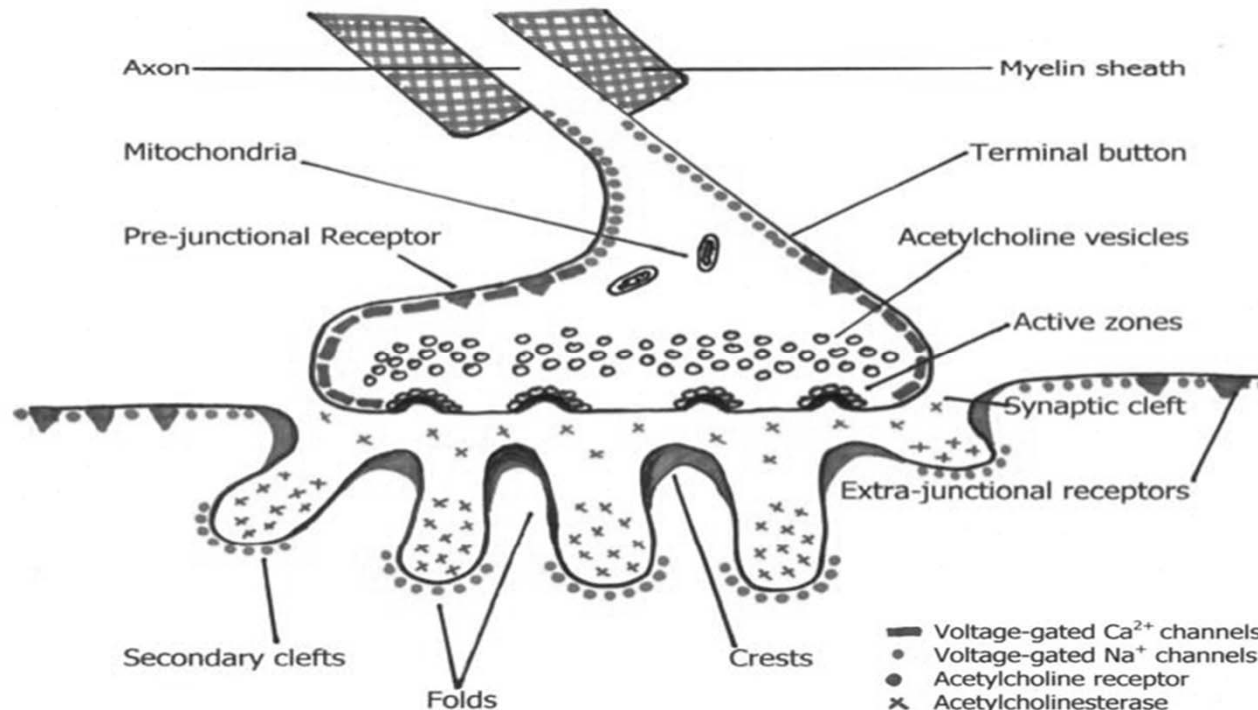

# Neuromuscular Junction<sub>4</sub>

- The post-junctional membrane receptors of the motor endplate are nicotinic acetylcholine receptors
  - Ligand-gated channel
  - Non-selective cationic channel

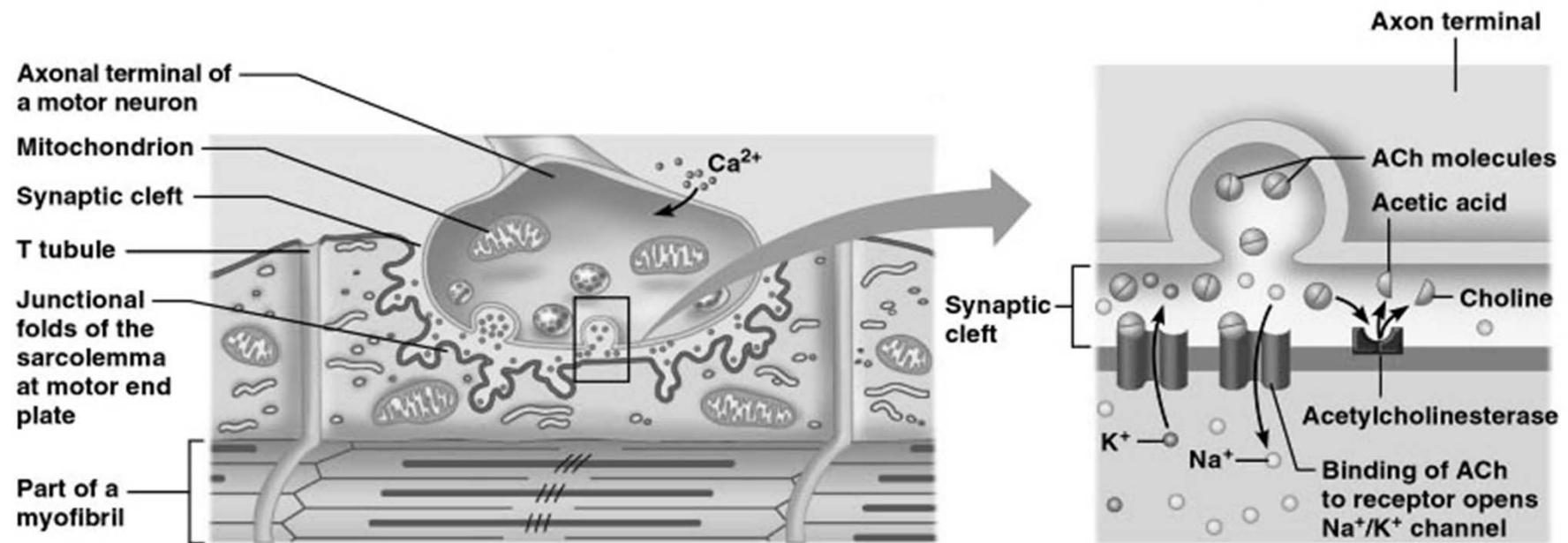

# Neuromuscular Junction<sub>5</sub>

- The influx of sodium ions reduces the charge, creating an End Plate Potential (EPP)
- If the end plate potential reaches the threshold voltage → an Action Potential (AP)
- The release of acetylcholine into the synaptic cleft may be spontaneous or in response to a nerve impulse
  - Spontaneous release of single vesicles of acetylcholine occurs randomly and results in Miniature EndPlate Potentials (MEPP)

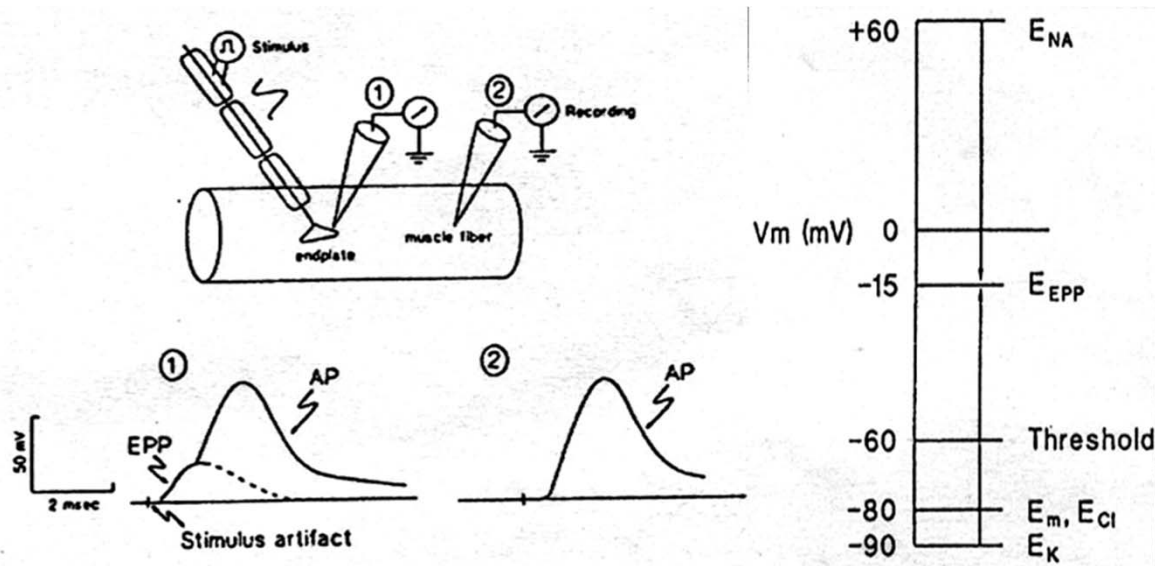
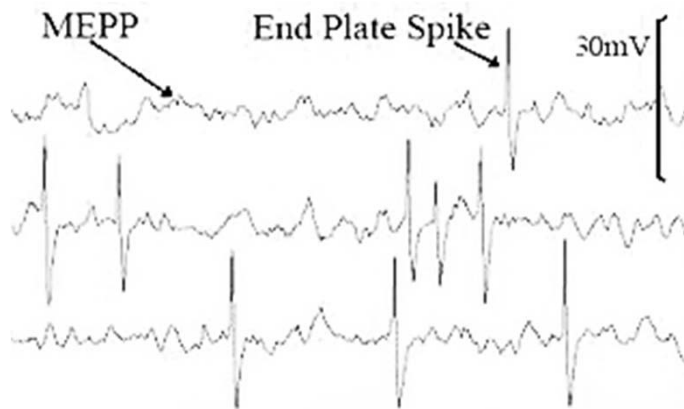

# Neuromuscular Junction<sub>6</sub>

- Ach is hydrolyzed to choline and acetic acid by acetylcholinesterase (AChE)
- The choline produced by the action of AChE is recycled — it is transported, through reuptake, back into nerve terminals where it is used to synthesize new acetylcholine molecules

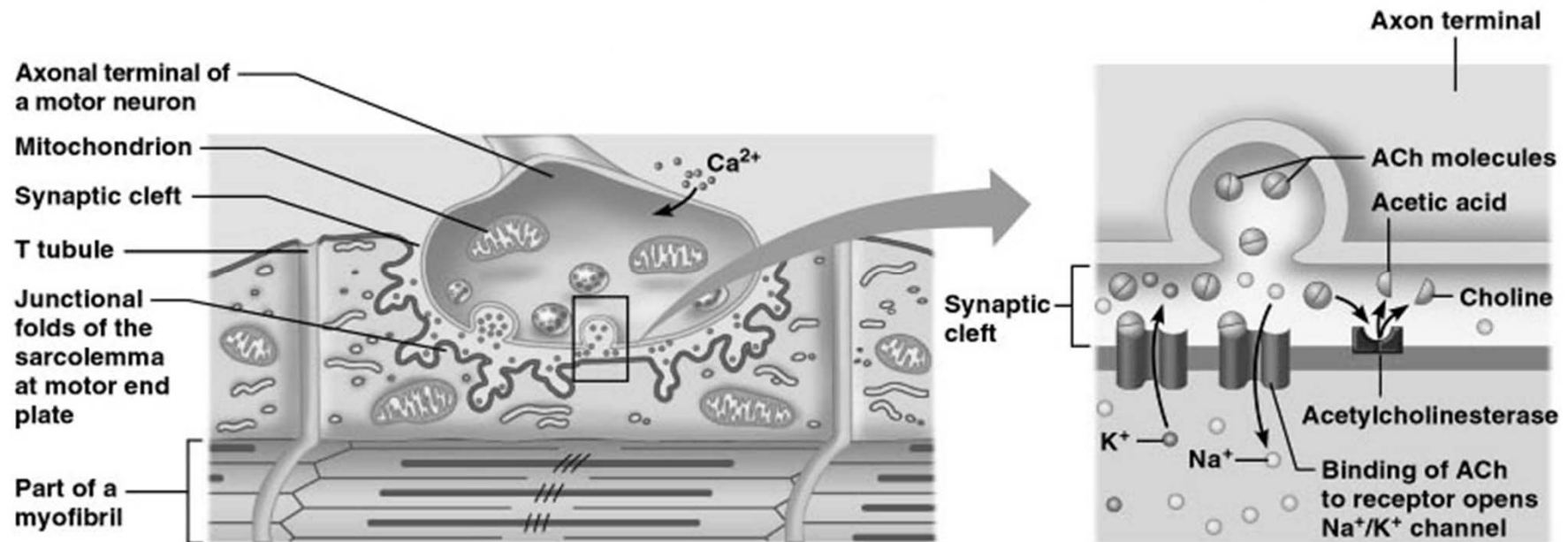



# Quiz\_11

How to prolong the function of acetylcholine at neuromuscular junction?

(A) add cholinesterase

(B) add cholinesterase inhibitor



<https://forms.gle/2Yn16gduZw38gBZn6>

# Neuromuscular Junction Disease

## Curare

- A toxic alkaloid found in certain tropical south American trees
- A non-depolarizing muscle relaxant which blocks the nicotinic acetylcholine receptor
- Competitive against acetylcholine
- The antidote is cholinesterase inhibitor



## Myasthenia gravis (literally "serious muscle-weakness")

- A neuromuscular disease leading to fluctuating muscle weakness and fatigue
- An autoimmune disorder, in which weakness is caused by antibodies from thymus, which block acetylcholine receptors
- Treated with cholinesterase inhibitors or immunosuppressants

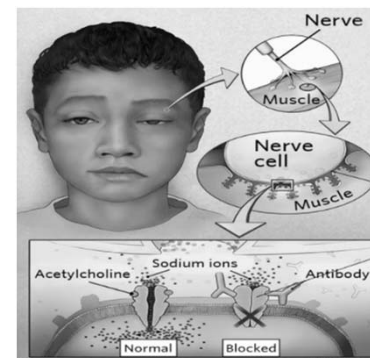

# Process of Skeletal Muscle Contraction

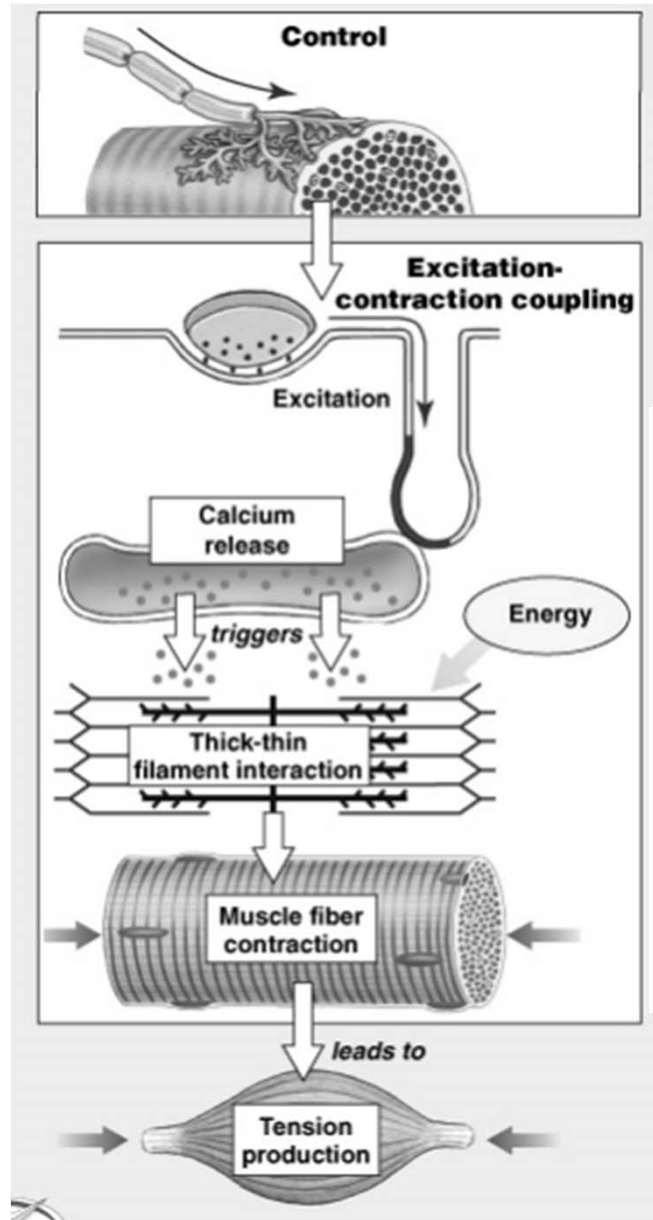

Phase 2: Excitation-contraction coupling occurs

## Excitation Contraction Coupling

- (6) Generation of action potential in muscle fibers.
- (7) Inward spread of depolarization along T tubules.
- (8) Release of  $Ca^{2+}$  from terminal cisterns of sarcoplasmic reticulum and diffusion to thick and thin filaments.
- (9) Binding of  $Ca^{2+}$  to troponin C, uncovering myosin-binding sites on actin.
- (10) Formation of cross-linkages between actin and myosin and sliding of thin on thick filaments, producing shortening.

Effect of n. stimulation on skeletal m.:  
excitation only

# Events of M. Contraction

- An action potential is propagated across the surface membrane and down T tubules of the muscle cell

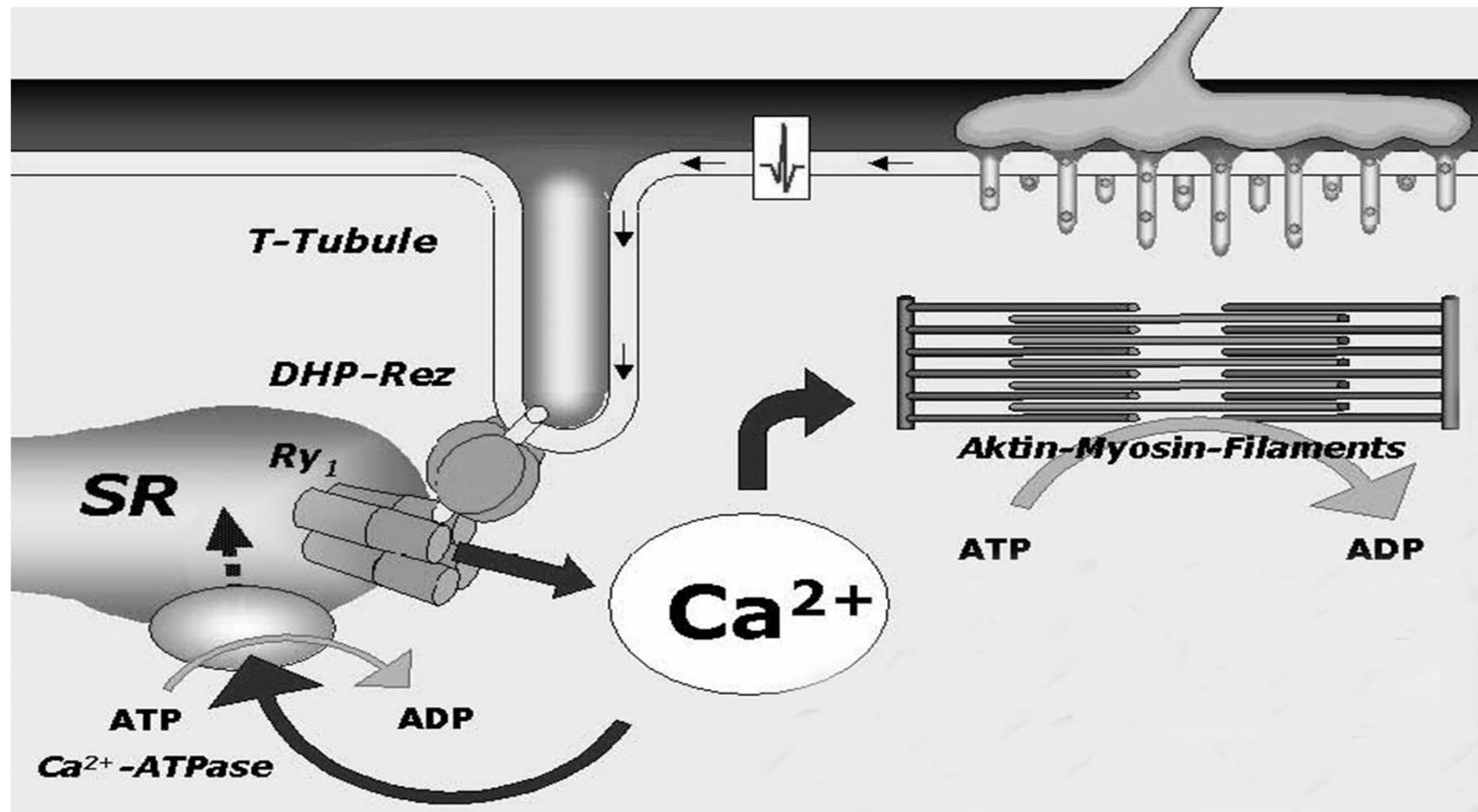

# Events of M. Contraction

- Dihydropyridine (DHP) receptor: act as voltage sensors on T tubule
- Ryanodine receptor: regulate  $\text{Ca}^{2+}$  release from the SR cisternae

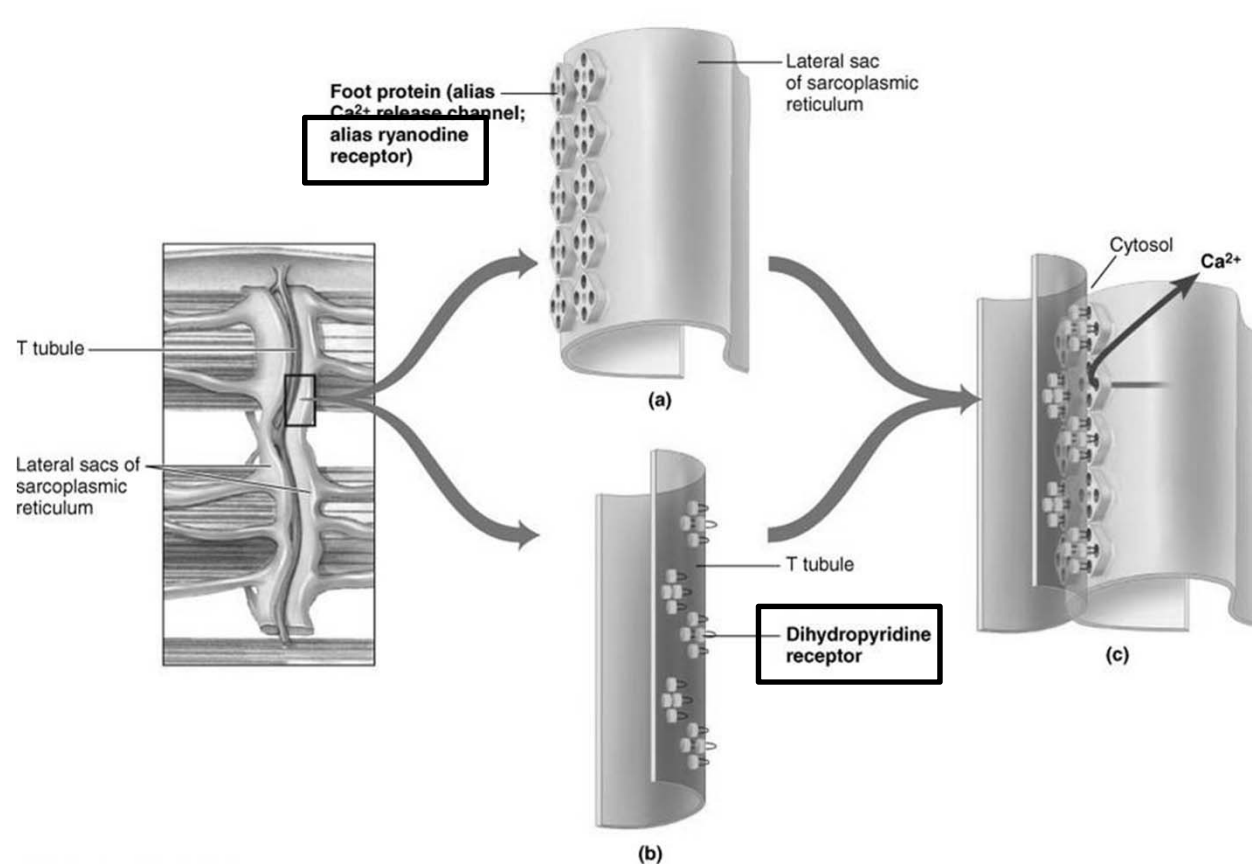

# Molecular Mechanisms of Contraction

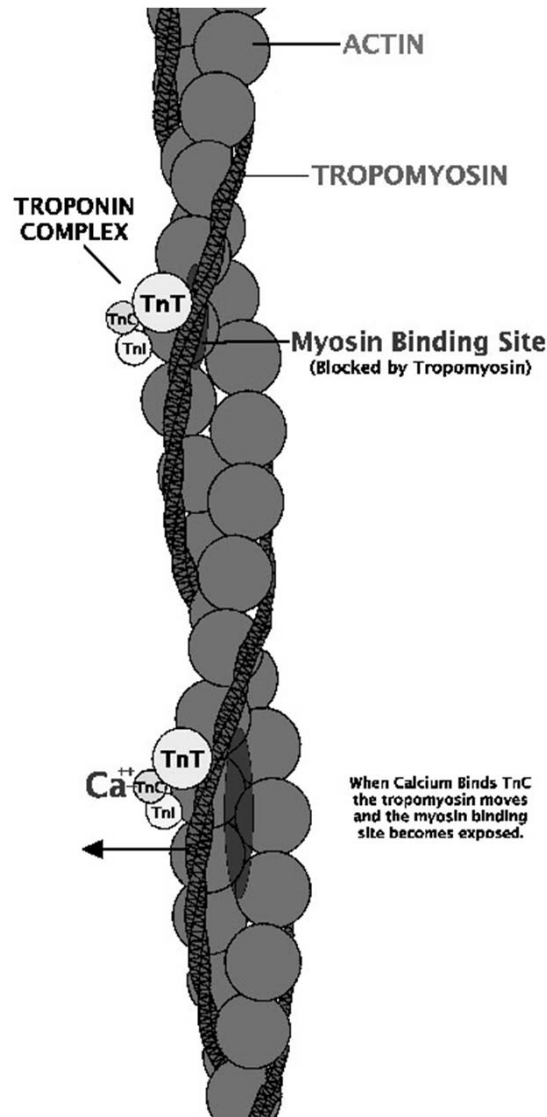

- When m. is relaxed,  
→ Myosin binding site on actin is blocked by tropomyosin
- $\text{Ca}^{2+}$  is released from sarcoplasmic reticulum  
→  $\text{Ca}^{2+}$  binds TnC  
→ Tropomyosin moves  
→ Myosin binding site is exposed
- Contraction of striated m. (skeletal m. & cardiac m.) is mediated by thin filament

When Calcium Binds TnC the tropomyosin moves and the myosin binding site becomes exposed.

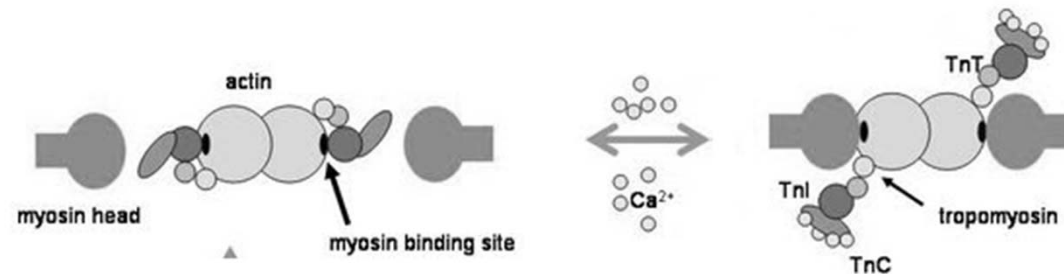

# Crossbridge Cycle<sub>1</sub>

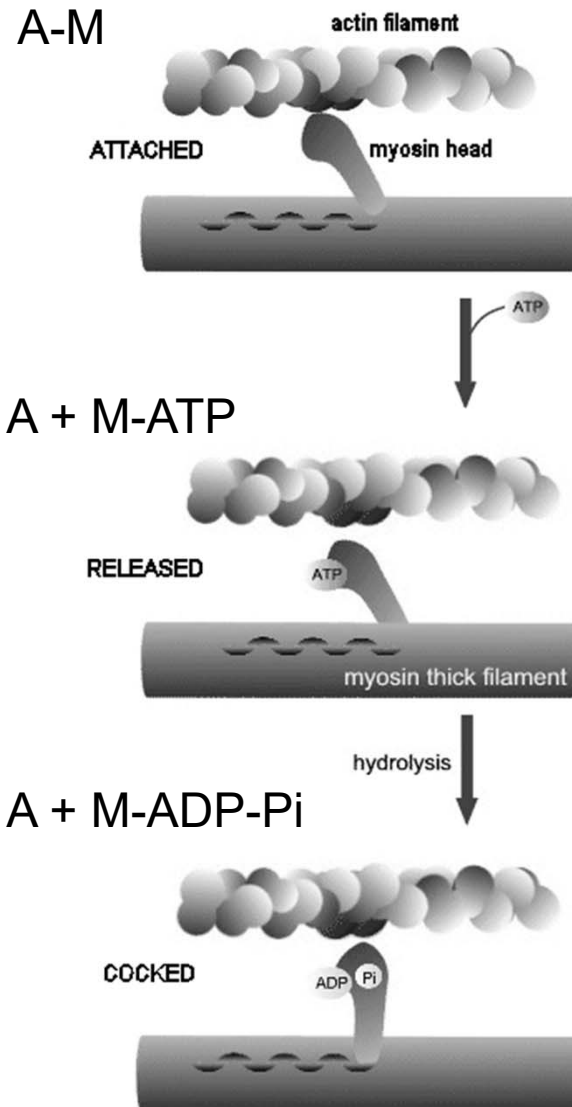

- A contractile cycle begins when a myosin filament is tightly bound to an actin filament in a *rigor* configuration

- rigor mortis (屍僵): few ~ 12 hours after death

- This state is rapidly terminated when an ATP molecule binds to the myosin head

- ATP causes a change in the myosin head which allows the head to move in cocked position

- Hydrolysis of ATP occurs, but ADP and Pi remain bound to the myosin head

# Crossbridge Cycle<sub>2</sub>

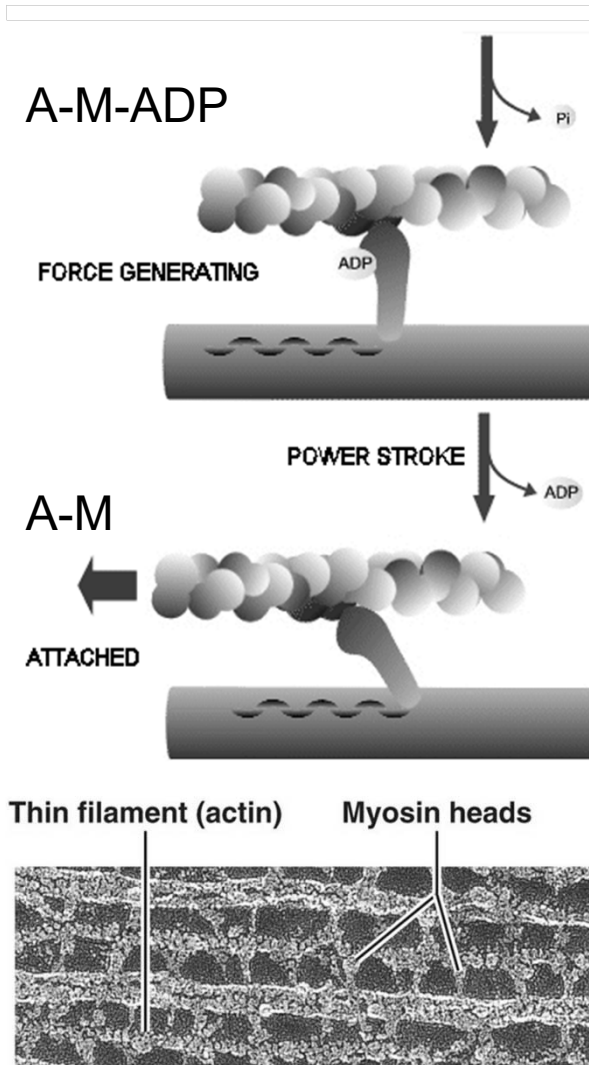

- In the presence of  $\text{Ca}^{2+}$ , the myosin head binds to a new binding site on the actin filament together with release of  $\text{P}_i$ , which triggers the power stroke

- During this phase the myosin head returns to its original conformation and ADP is released

Each cycle: Move about 10 nm, consume 1 ATP



# Summary of Crossbridge Cycle

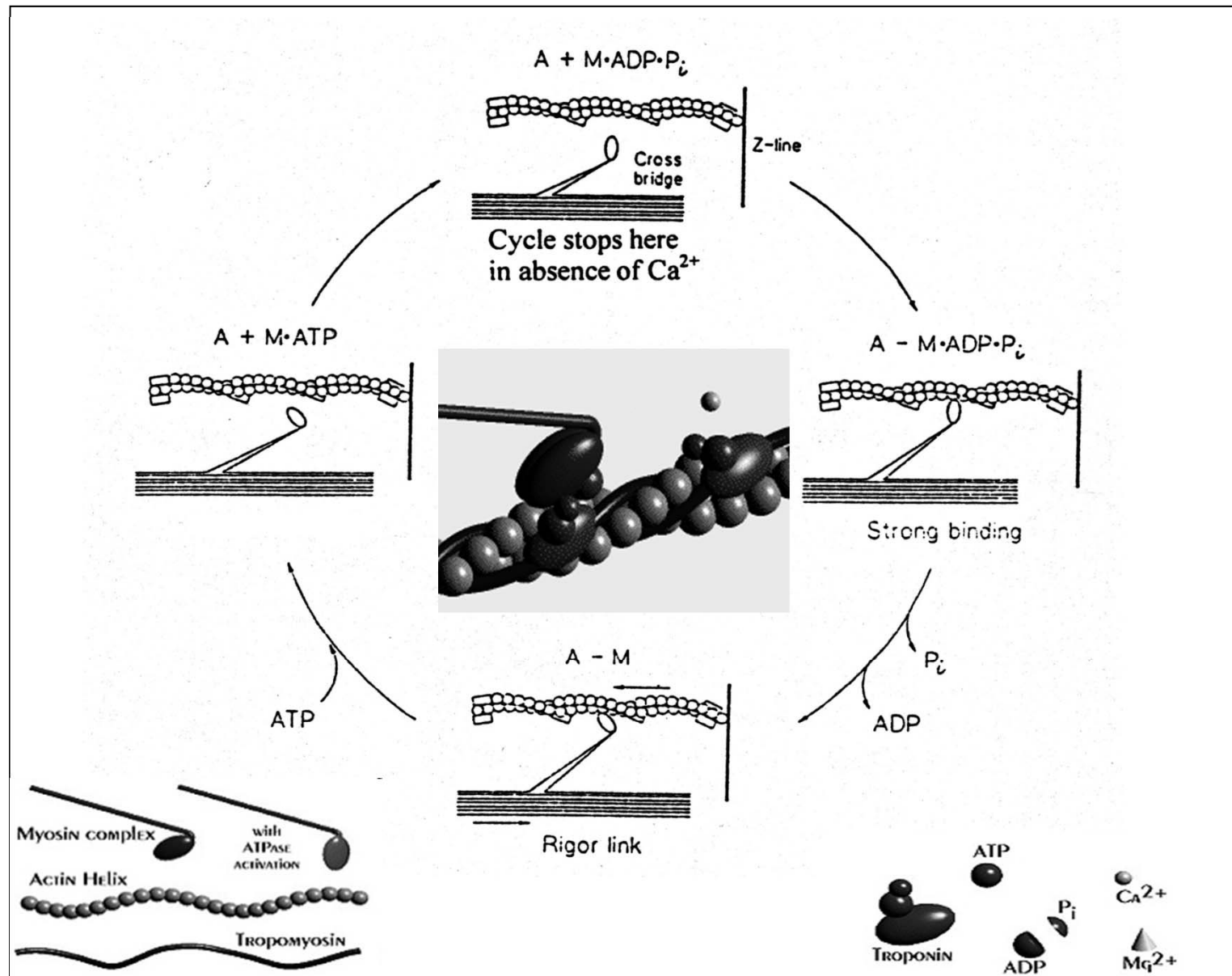



## Breakdown of ATP and Cross-bridge Movement During Muscle Contraction

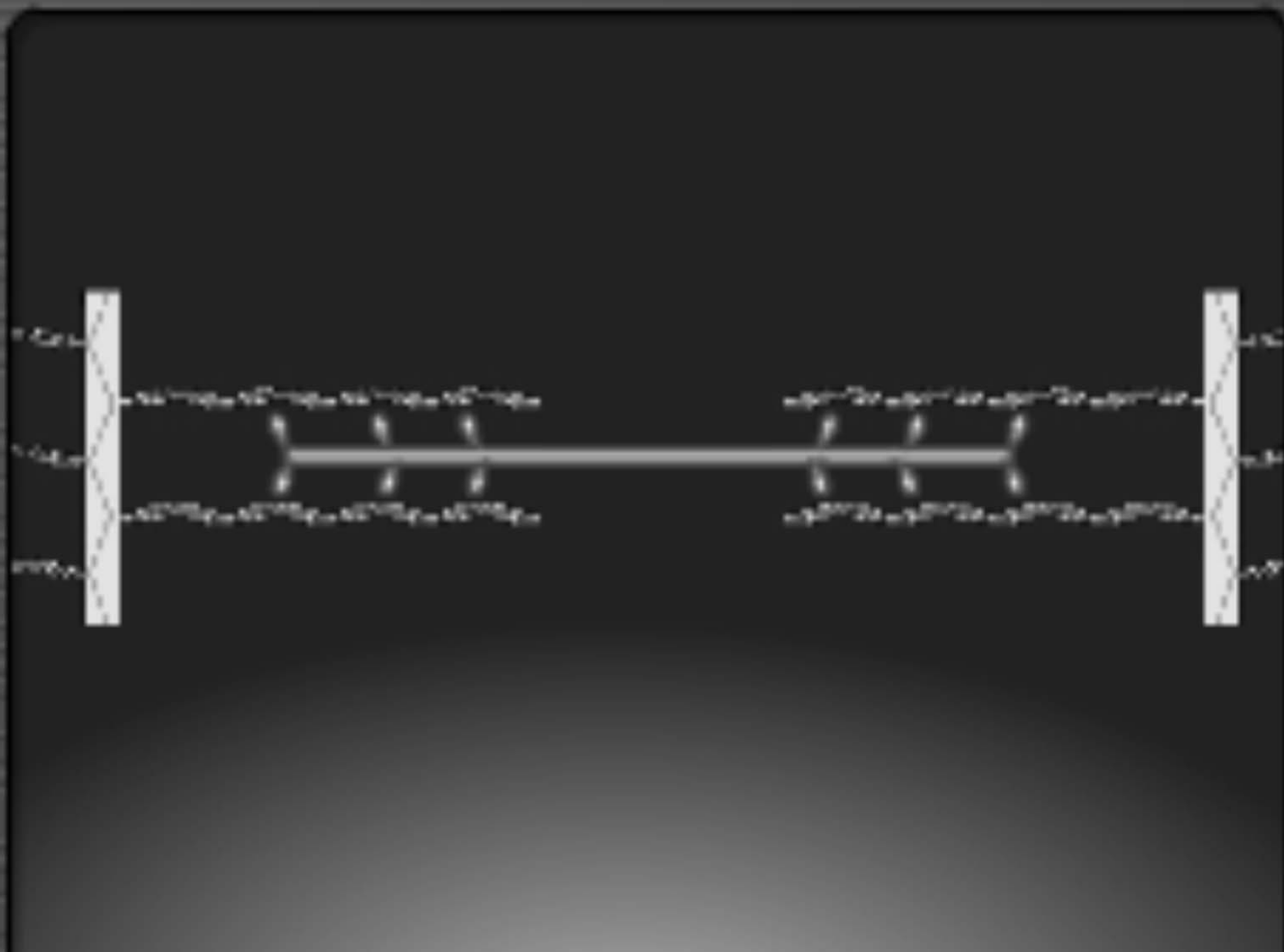

▶ Play    ⏸ Pause    🔊 Audio    📄 Text

During contraction of a muscle, calcium ions ( $\text{Ca}^{2+}$ ) bind to troponin. This moves tropomyosin out of the way and uncovers binding sites for myosin on the actin myofilaments.

# Process of Skeletal Muscle Contraction

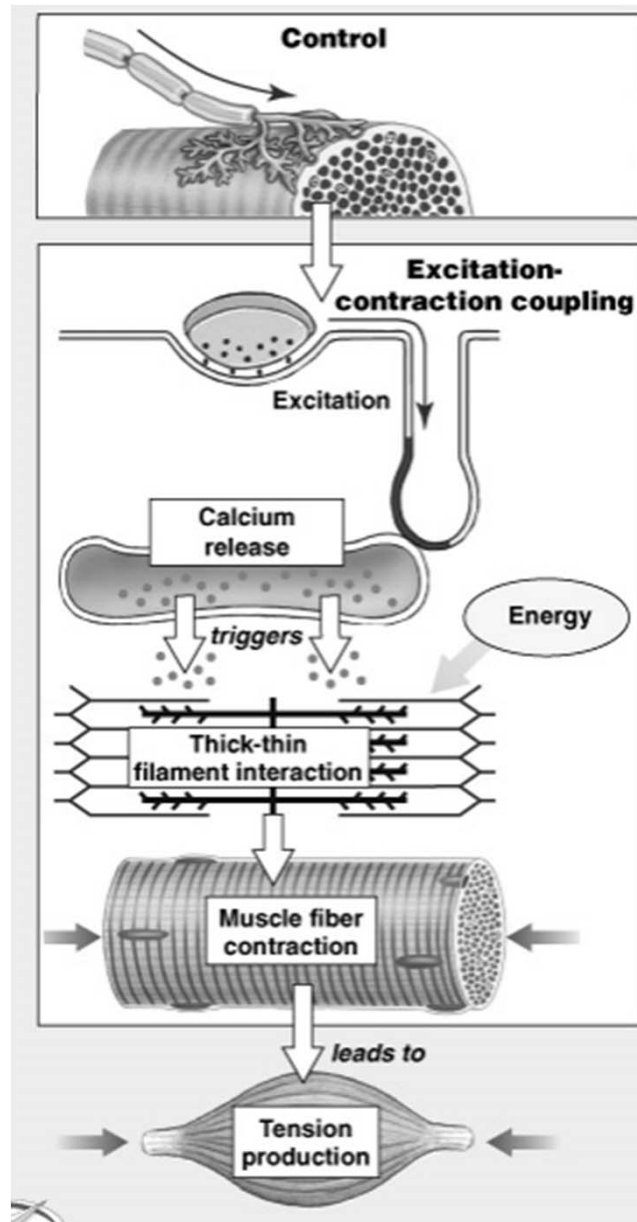

## Steps in contraction<sup>1</sup>

- (1) Discharge of motor neuron.
- (2) Release of transmitter (acetylcholine) at motor end-plate.
- (3) Binding of acetylcholine to nicotinic acetylcholine receptors.
- (4) Increased  $\text{Na}^+$  and  $\text{K}^+$  conductance in end-plate membrane.
- (5) Generation of end-plate potential.
- (6) Generation of action potential in muscle fibers.
- (7) Inward spread of depolarization along T tubules.
- (8) Release of  $\text{Ca}^{2+}$  from terminal cisterns of sarcoplasmic reticulum and diffusion to thick and thin filaments.
- (9) Binding of  $\text{Ca}^{2+}$  to troponin C, uncovering myosin-binding sites on actin.
- (10) Formation of cross-linkages between actin and myosin and sliding of thin on thick filaments, producing shortening.

# Process of Skeletal Muscle Relaxation

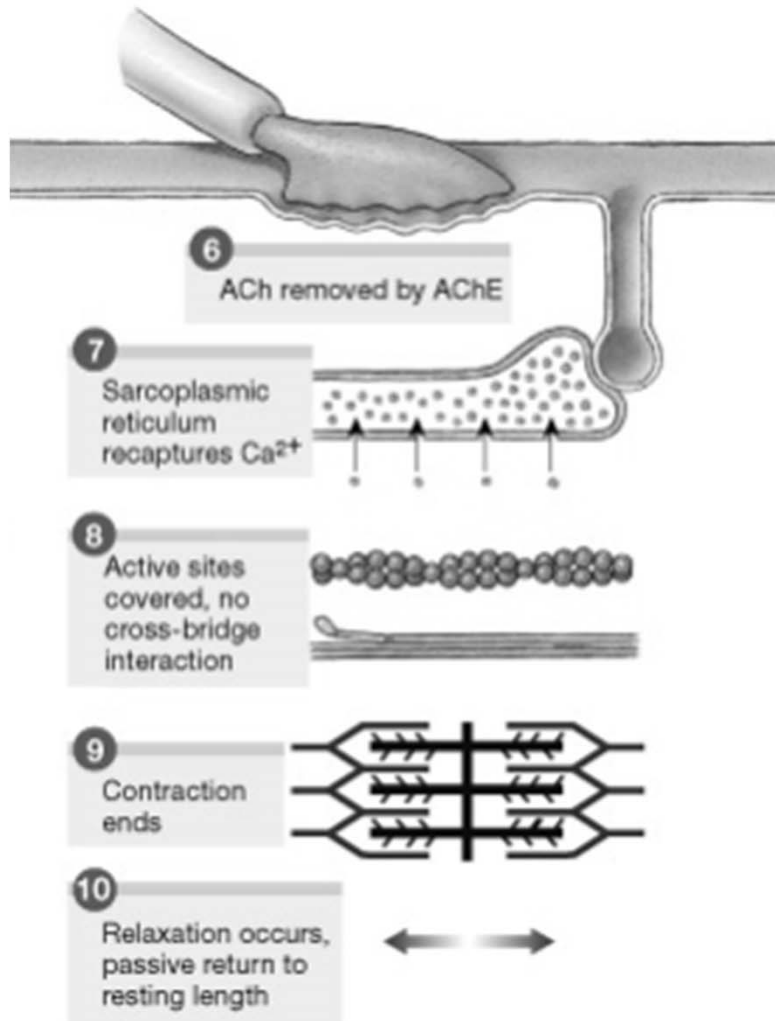

## *Steps in relaxation*

- (1)  $\text{Ca}^{2+}$  pumped back into sarcoplasmic reticulum.
- (2) Release of  $\text{Ca}^{2+}$  from troponin.
- (3) Cessation of interaction between actin and myosin.

\*  $\text{Ca}^{2+}$  is actively pumped back to SR, which is required ATP

# Muscle Cramps

- Involuntarily and forcibly contracted muscles that doesn't relax
- Caused by
  - hyperexcitability of the nerves: injury, vigorous activity
  - dehydration (sodium depletion), low blood calcium & magnesium
  - rest cramps (nocturnal cramps)
  - tetanus toxin
- Most muscle cramps can be stopped if the muscle can be stretched
- Muscle cramps can often be prevented by
  - adequate nutrition and hydration
  - attention to safety when exercising
  - attention to ergonomic factors

# Outlines

1. Background
2. Skeletal Muscle
  - Architecture & Structure
  - Sliding Filament Model of M. Contraction
  - Process of Skeletal M. Contraction
  - Control of Skeletal M. Contraction
  - Mechanics of Skeletal M. Contraction
  - Energetics of Skeletal M. Contraction
3. Smooth Muscle
  - Structural Characteristics
  - Smooth Muscle Contraction & Relaxation
  - Classification of Smooth Muscle
4. Cardiac Muscle

# Quiz\_12

Can voluntary muscles produce involuntary movement?

(A) Yes

(B) No



<https://forms.gle/qor344cRVCNpdPMh6>

# Skeletal Muscle Reflexes

- Skeletal muscles are usually referred to as voluntary and are controlled by higher brain regions
- They can also contract unconsciously in response to certain stimuli—Reflexes
- Reflexes have several types:
  - Monosynaptic stretch reflex: e.g., knee-jerk reflex
  - Disynaptic reflex: e.g., Golgi tendon organs
  - Complex reflex: e.g., reciprocal innervation



# Monosynaptic Stretch Reflex

- Simplest reflex
- Only involves a sensory neuron synapsing on a motor neuron in the spinal cord
  - One synapse = monosynaptic
- Maintains optimal resting length of skeletal muscles
- Can be stimulated by striking the patellar ligament in the “knee-jerk reflex”

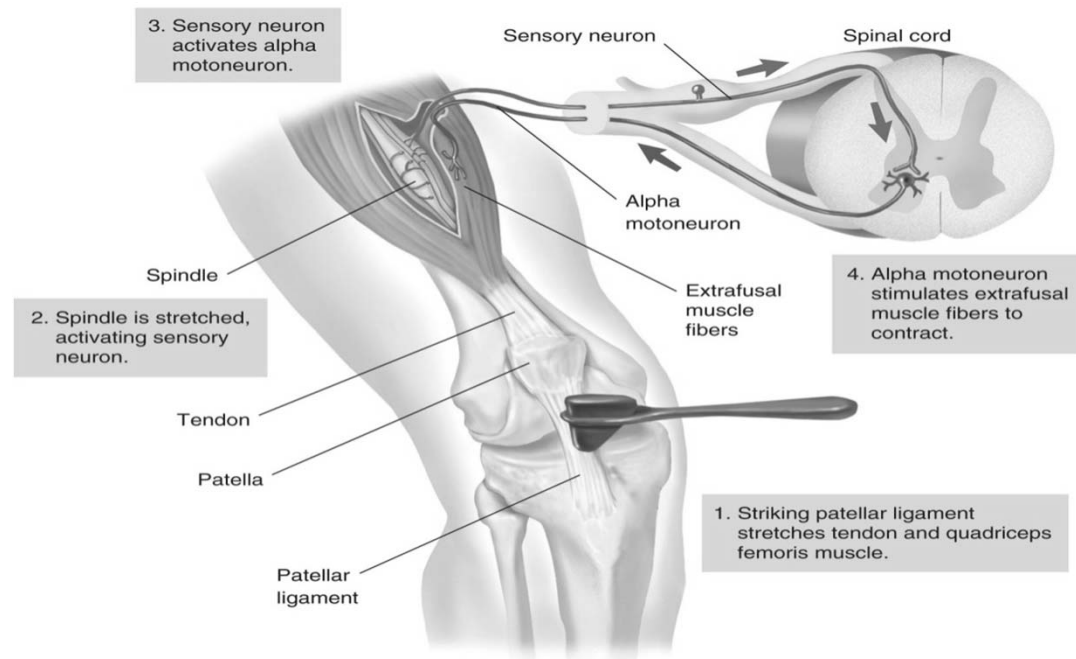

# Disynaptic Reflex

- Golgi Tendon Organs: constantly monitor tension in tendons
  - Sensory neuron stimulates interneuron in spinal cord
  - Interneuron inhibits excitation of alpha motor neurons
  - Tension in tendon is reduced
- Disynaptic reflex involves two synapses

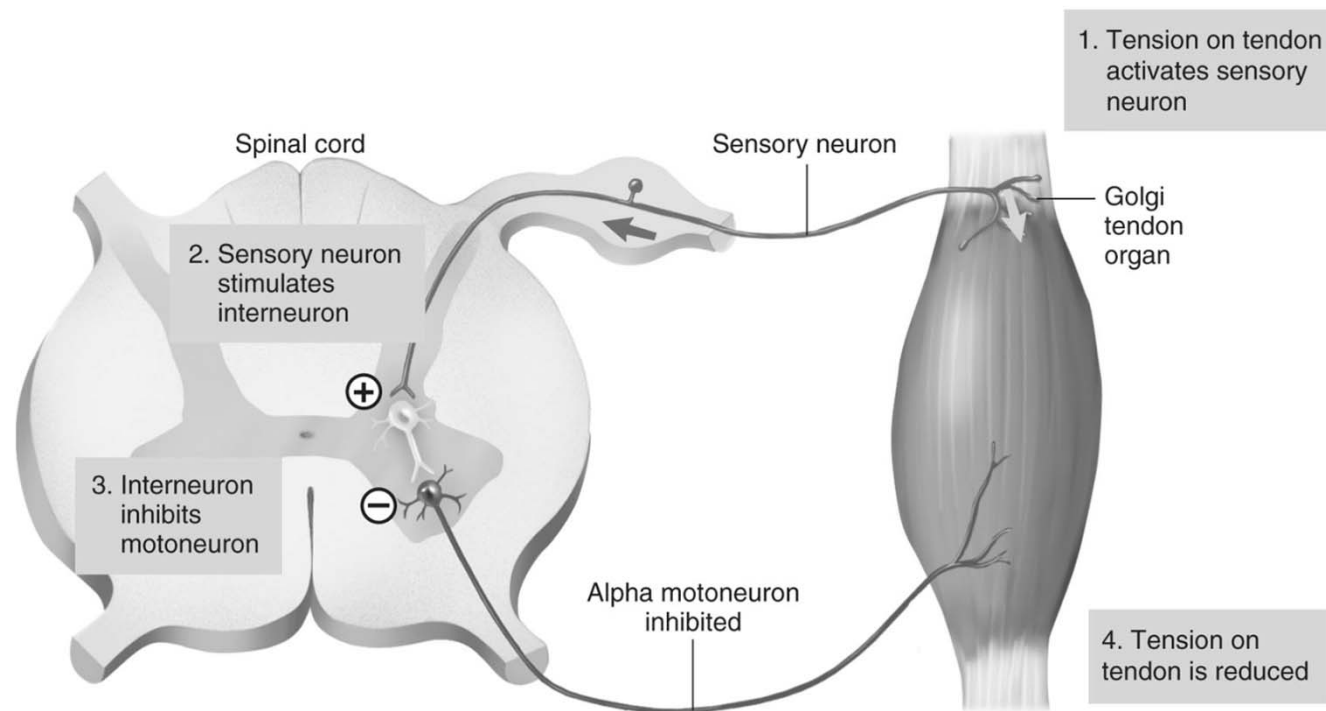

# Reciprocal Innervation

- In the knee-jerk reflex, interneurons are also stimulated in the spinal cord to inhibit antagonistic muscles on that limb
- More complex reflexes require control of muscles on the contralateral limb. This is called double reciprocal innervation (e.g., crossed extensor reflex when stepping on a tack)

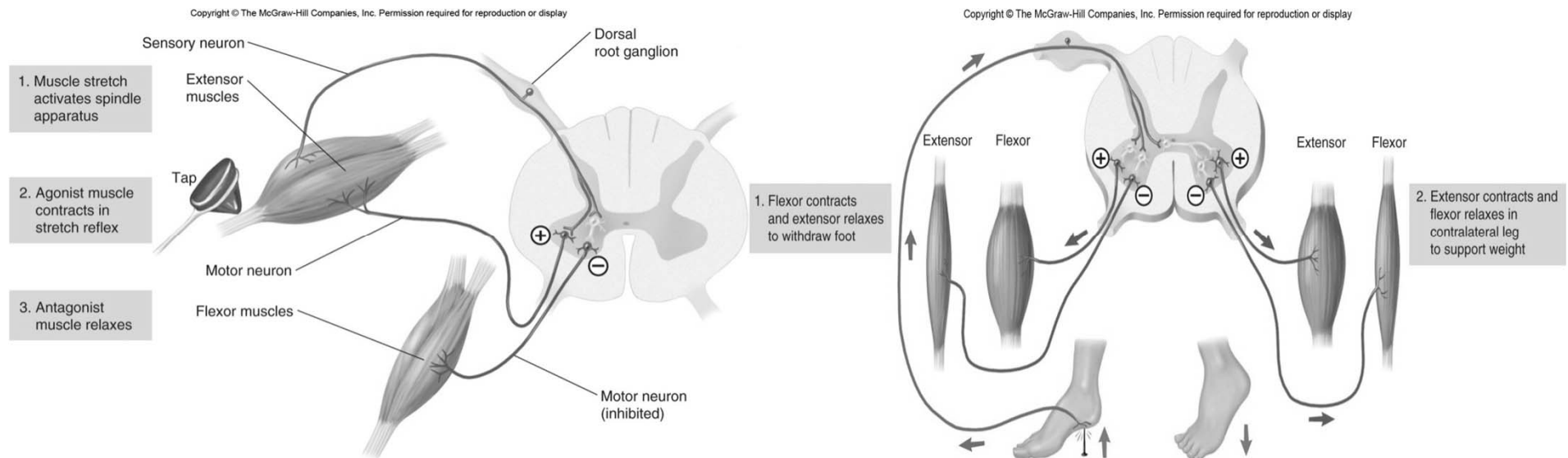

# Outlines

1. Background
2. Skeletal Muscle
  - Architecture & Structure
  - Sliding Filament Model of M. Contraction
  - Process of Skeletal M. Contraction
  - Control of Skeletal M. Contraction
  - Mechanics of Skeletal M. Contraction
  - Energetics of Skeletal M. Contraction
3. Smooth Muscle
  - Structural Characteristics
  - Smooth Muscle Contraction & Relaxation
  - Classification of Smooth Muscle
4. Cardiac Muscle

# Types of Muscle Contraction

- Isometric contraction: no change in length but tension increases, e.g. postural muscles of body
  - Co-contraction of antagonist muscle
- Isotonic contraction: change in length but tension constant
  - Concentric: overcomes opposing resistance and muscle shortens
  - Eccentric: tension maintained but muscle lengthens

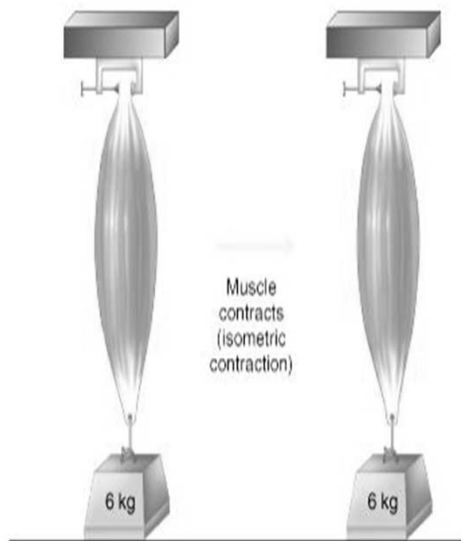

(b) Isometric contraction

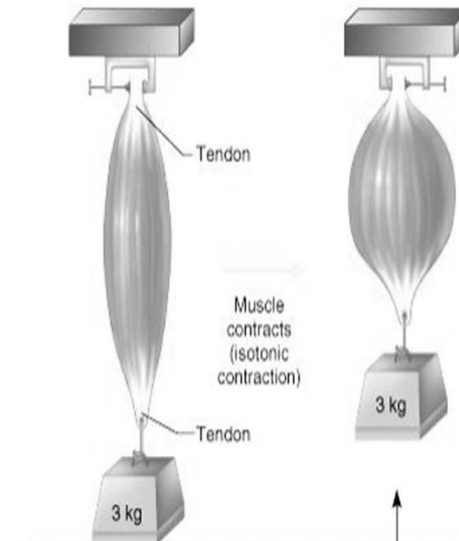
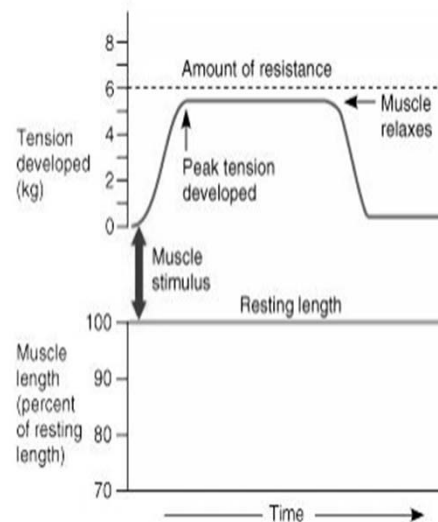

(a) Isotonic (concentric) contraction

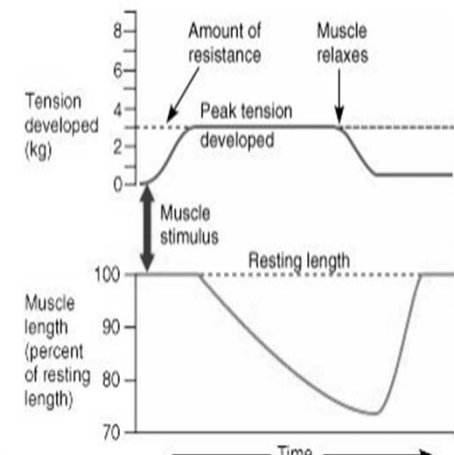

# Isotonic Contraction With Different Loads

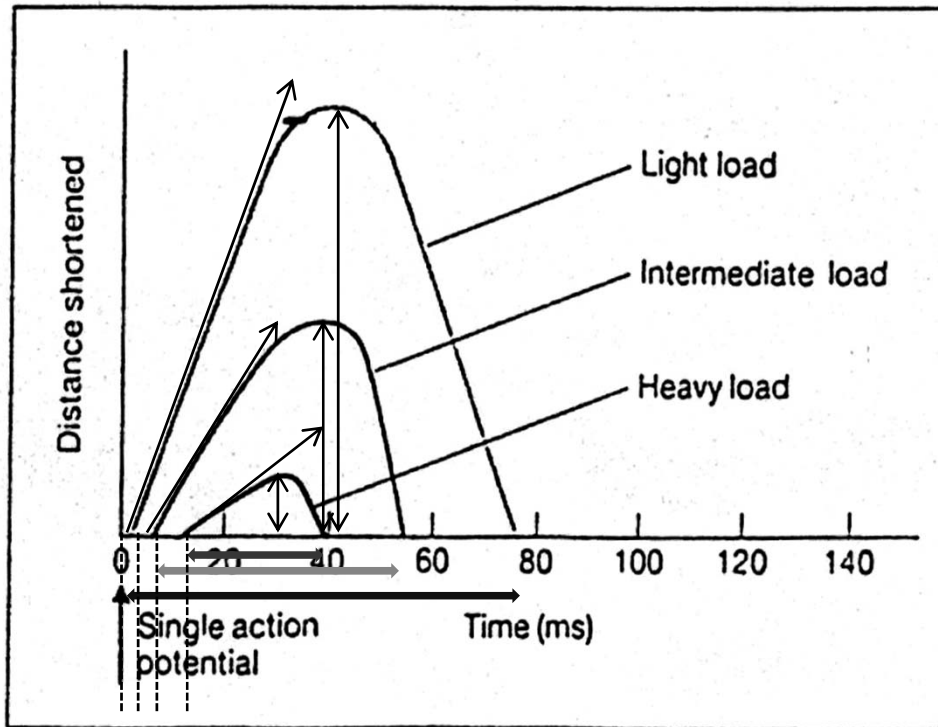

As load increases,

- Max. distance shortened ↓
- Shortening velocity ↓
- Duration of shortening ↓

BUT

- Latent period ↑

# Load-Velocity Relation

- During isotonic contraction: the velocity of muscle shortening is inversely proportional to the magnitude of the load

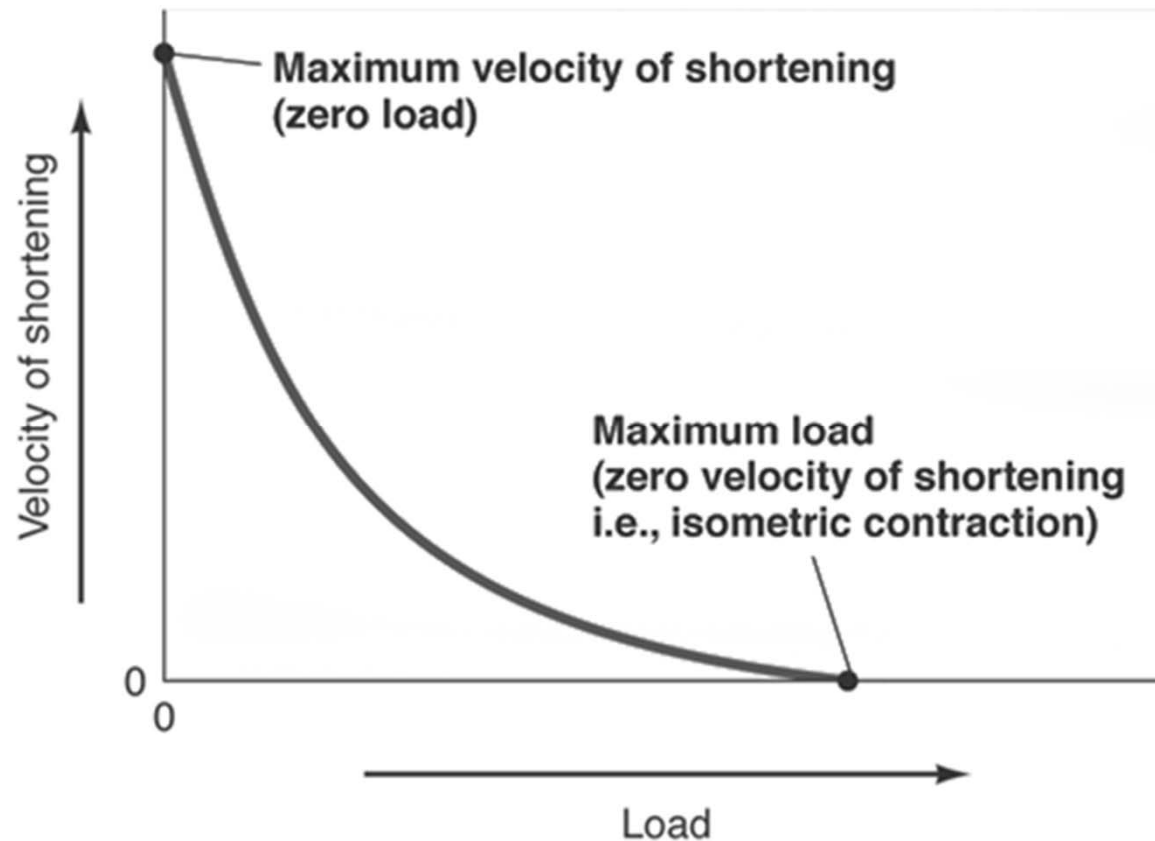

# Quiz\_13

We exert different levels of muscle force.

- (A) True
- (B) False

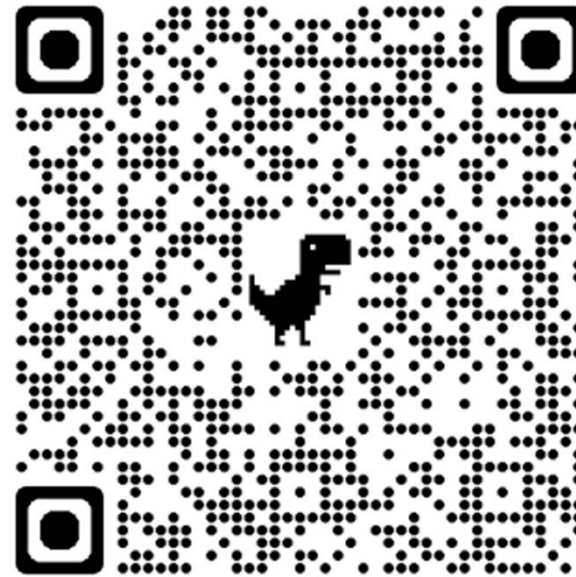

<https://forms.gle/V2LGgkVpBunV6KKb6>



# Quiz\_14

Are all-or-none law applied for muscle fibers?

(A) Yes

(B) No

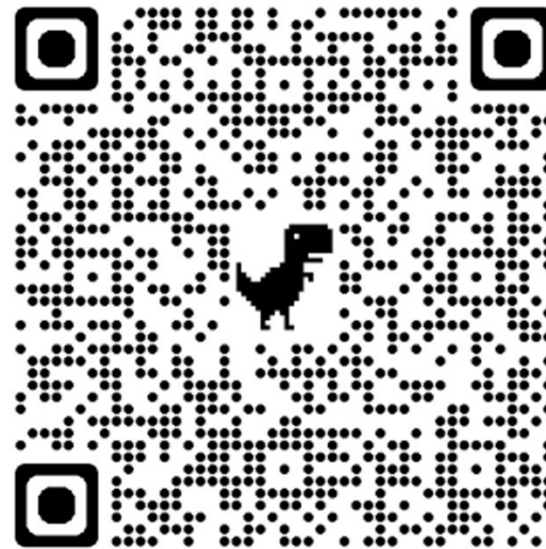

<https://forms.gle/brr6qGDAYrHemSM98>

# Different Response of M. Fiber vs. Whole Muscle

- All-or-none law for muscle fibers: contraction of equal force in response to each action potential
- Graded for whole muscles: strength of contractions range from weak to strong depending on several factors
  - Numbers of myofibrils working in parallel
    - Thicker m. have greater strength than thinner ones
    - Exercise adds myofibrils (hypertrophy) by adding more actin and myosin
  - Recruitment of motor units (groups of muscle fibers)
  - Frequency of stimulation
  - Muscle length
  - Fatigue

# Motor Unit<sub>1</sub>

- Lower motor neurons: cell bodies in ventral horn of spinal cord
  - Influenced by
    - Sensory feedback from muscles and tendons
    - Stimulation or inhibition from upper motor neurons
- Motor unit: a motor neuron and all of the corresponding muscle fibers it innervates
  - When a motor unit is activated, all of its fibers contract

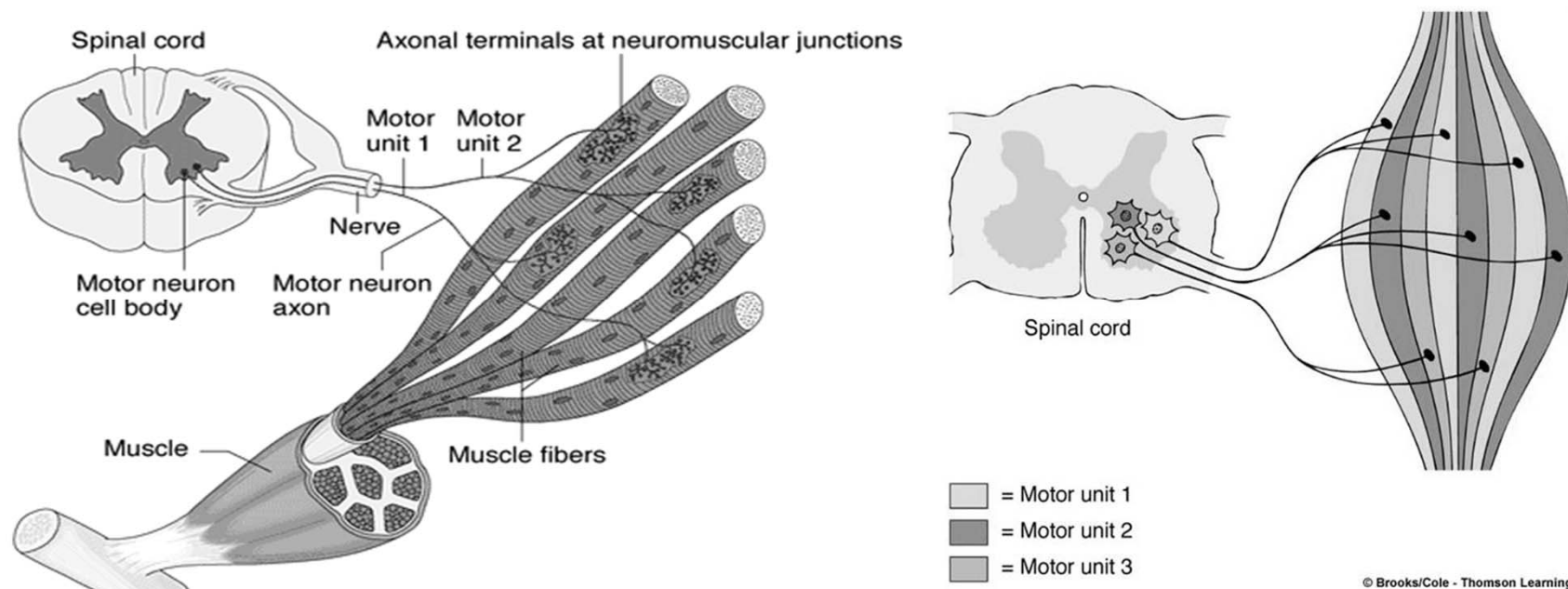

# Motor Unit<sub>2</sub>

- Alpha motor unit: the motor neurons that innervate the extrafusal m. fibers
- Gamma motor unit: the motor neurons that innervate the intrafusal m. fibers
- These motor units are stimulated by lower and upper motor neurons at the same time = coactivation

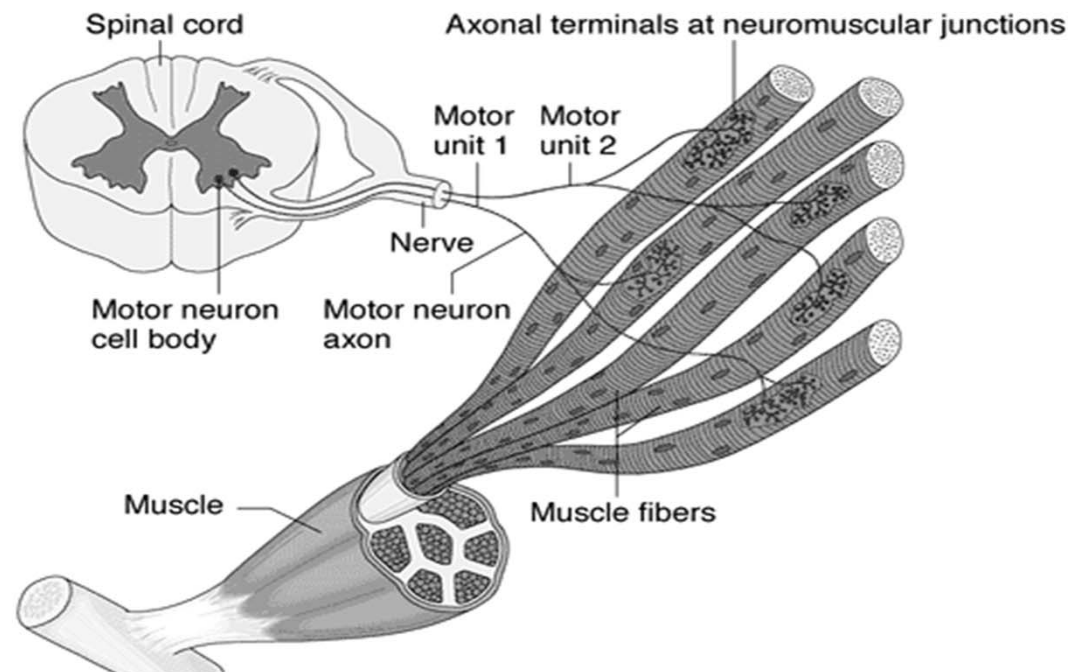

# Motor Unit<sub>3</sub>

- The number of muscle fibers within each unit can vary
  - The smaller the motor unit, the more precise the action of the muscle
  - back m. (1:100); finger m. (1:10); eye m. (1:1)
- The strength of entire muscle increases by recruiting more motor units
- Size principle: Large motor units require the greater amplitude of stimulus to become active
  - Smaller motor units are more excitable than larger motor units
  - Smaller motor units are activated first

# Muscle Tone

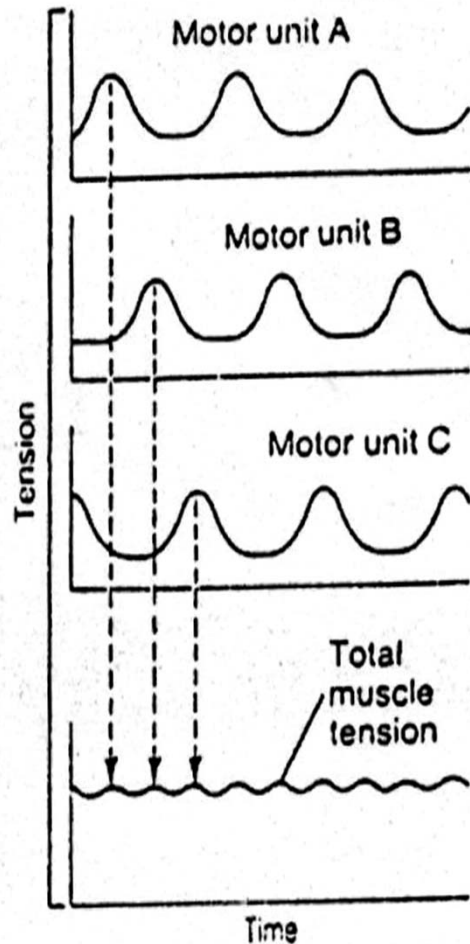

- Definition: the constant, slightly contracted state of all muscles, which does not produce active movements
- Cause: the result of asynchronous muscle motor unit contraction
- Function:
  - Maintain a constant force without tiring out individual muscle fibers
  - Keep the muscles of the body firm and ready to respond to stimuli
  - Help stabilize joints and maintain posture

# Frequency-Tension Relation<sub>1</sub>

- Summation: increase in contractile response to a second action potential that occurs during the contractile response produced by the previous action potential
  - Due to insufficient time to pump  $\text{Ca}^{2+}$  back to sarcoplasmic reticulum (SR)
  - an increase in the amount of  $\text{Ca}^{2+}$  in the sarcoplasm

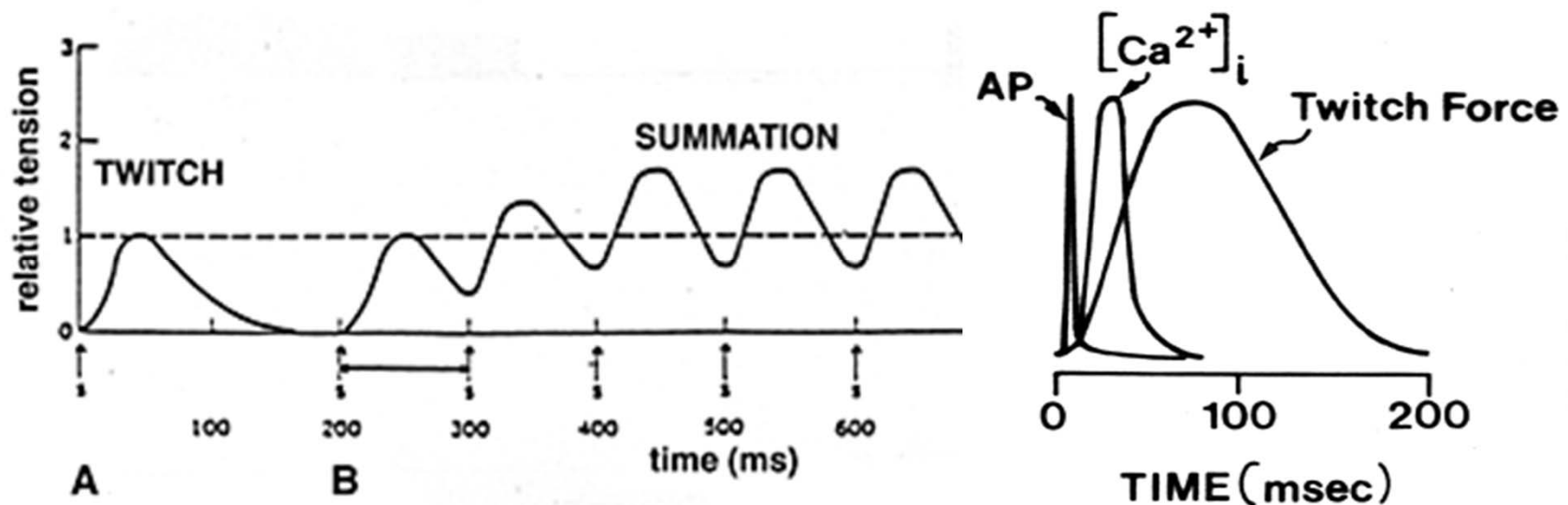

# Frequency-Tension Relation<sub>2</sub>

- Tetanus: response to multiple stimuli delivered at a rate sufficient to produce a fused contraction
  - Because all of the myofilaments are forming bonds (a maximum of  $\text{Ca}^{2+}$  in the myofibril)

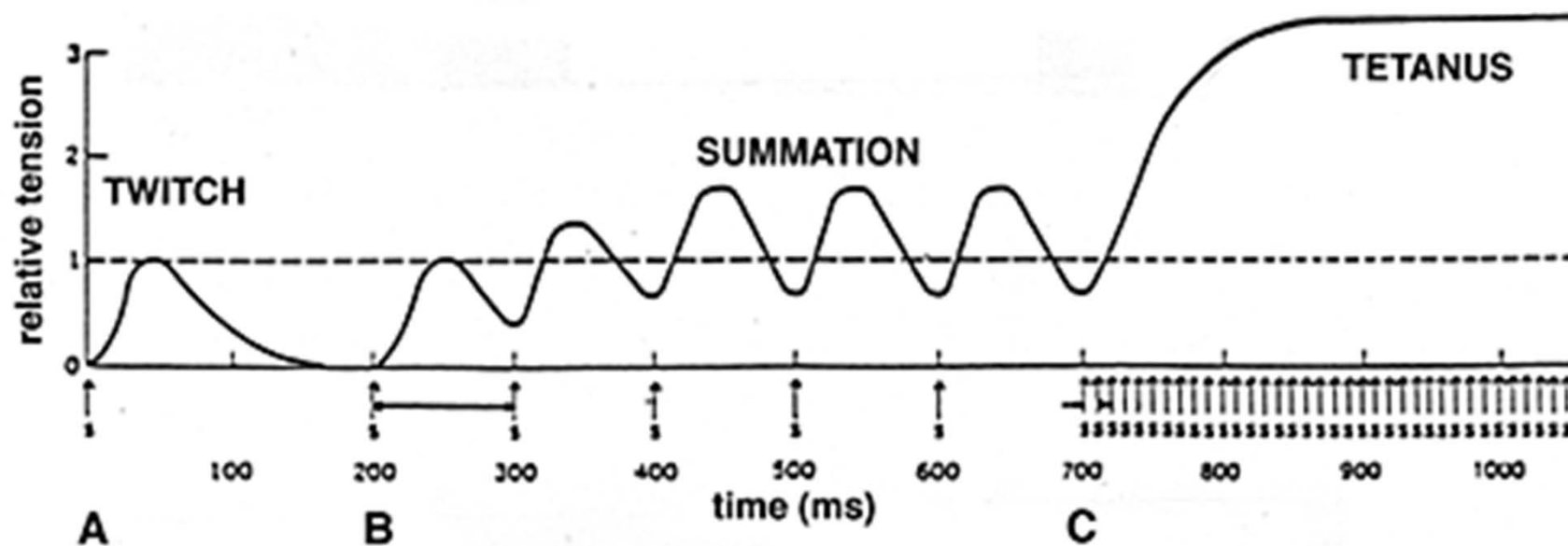



# Muscle Force<sub>1</sub>

- Passive force: the force required to stretch a relaxed muscle to a given length

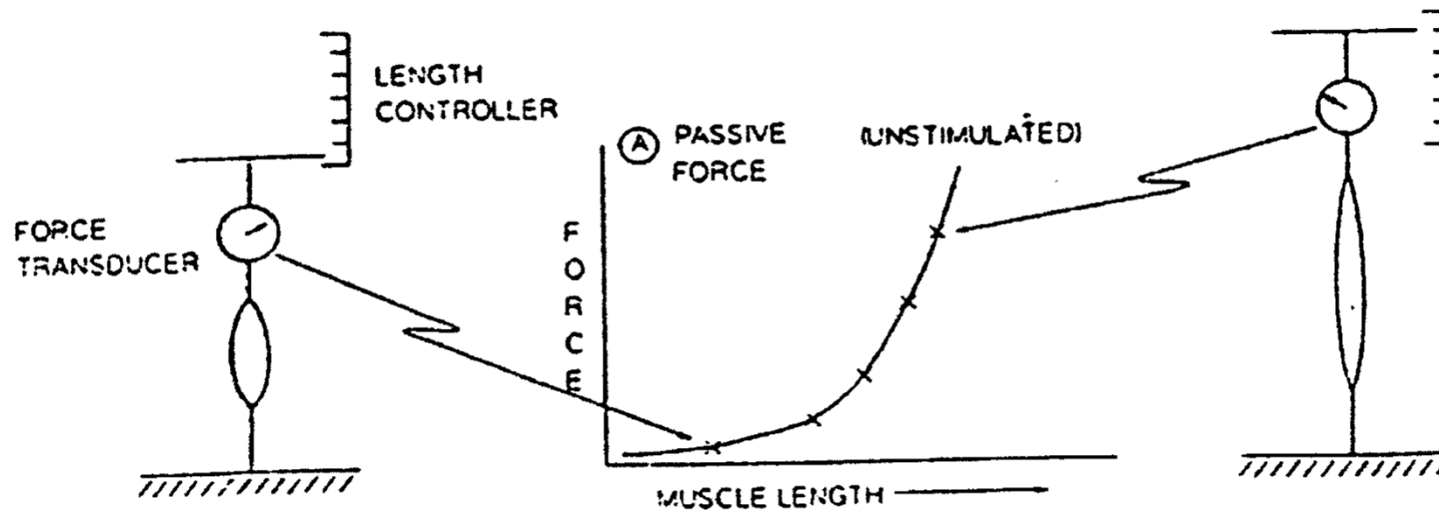

- Active force: the force generated by the attachment of cross bridges

# Muscle Force<sub>2</sub>

- Total force: the final force that a muscle attains following stimulation
  - the passive force that existed prior to stimulation
  - the component of force that was generated in response to the stimulus

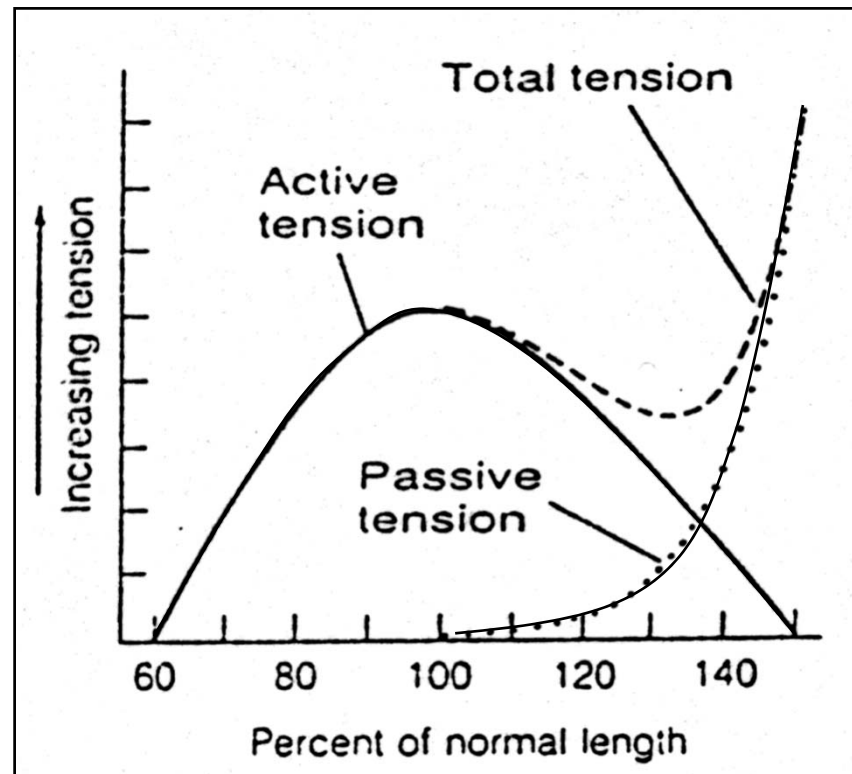

# Length-Tension Relation<sub>1</sub>

- The dependence of active force on muscle length is related to extent of overlap between thick and thin filaments in the sarcomere
- Filament overlap hypothesis
  - the greater the overlap  $\rightarrow$  the greater the number of cross bridges that can interact with actin

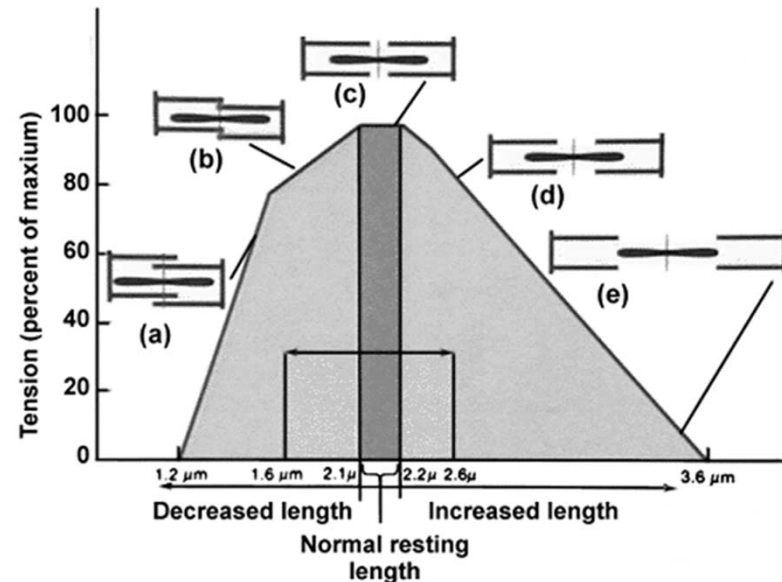
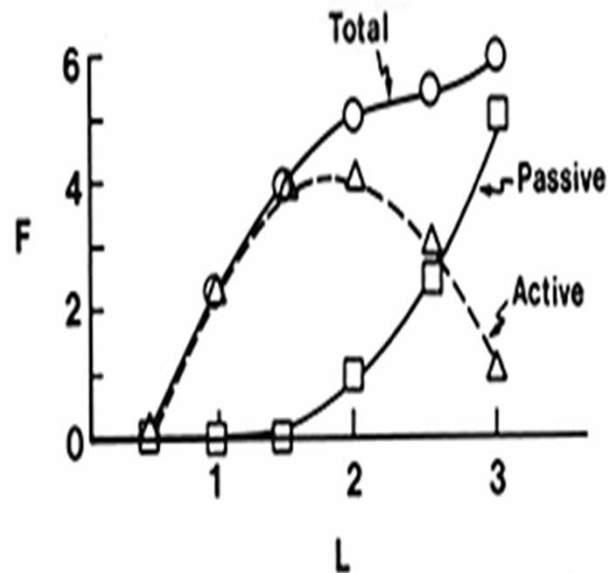

# Quiz\_15

Why the active tension decreased when the muscle length is shorter than the normal resting length?



<https://forms.gle/ANSTA5DwuUQq3pTS9>

# Length-Tension Relation<sub>2</sub>

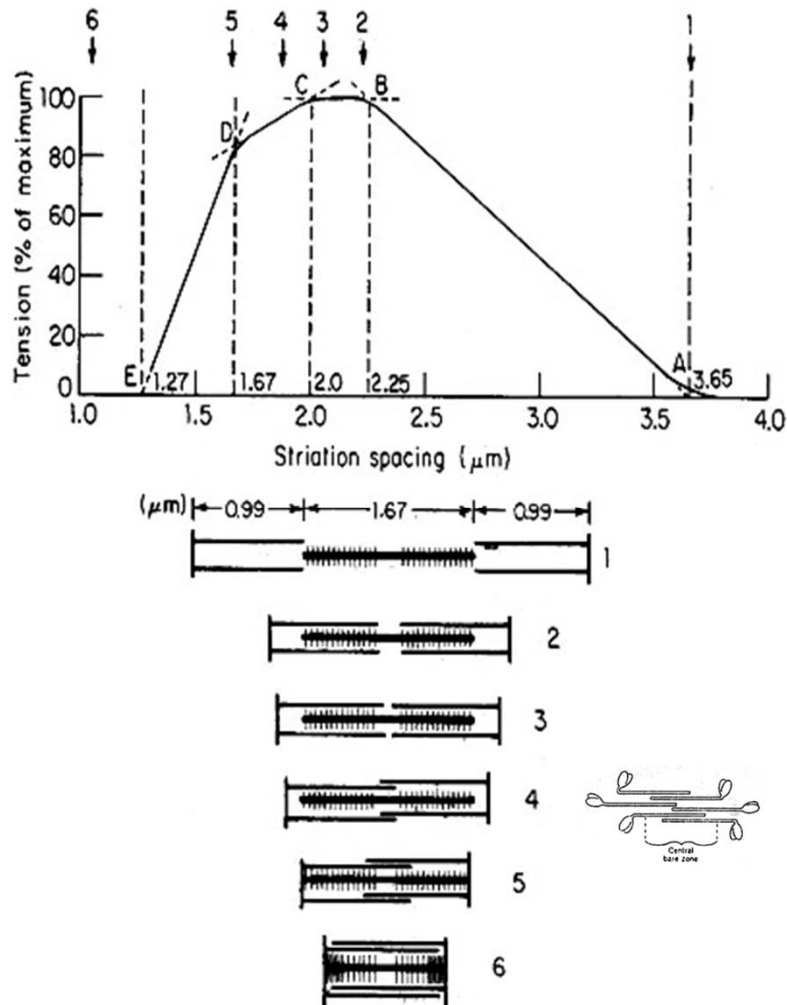

- Below rest length, tension drops off
- the thin filaments enter the bare zone (4)
  - the thin filaments start to interact with the oppositely directed cross bridge sites past the bare zone (5)
  - collision of the tips of the thick filaments with the Z-line (6)
  - less calcium is released from the sarcoplasmic reticulum at short sarcomere lengths

# Muscle Fatigue

- Effect of nervous system stimulation on skeletal m.: excitation only
- When muscle can no longer respond to stimulation with same degree of contractile activity
- Asynchronous recruitment of motor units used to limit muscle fatigue (i.e., fibers "take turns" contracting)
- Types of muscle fatigue:
  - Muscular fatigue: due to ATP depletion, and failure of SR  $\text{Ca}^{2+}$  release, NOT due to lactic acid accumulation
  - Neuromuscular fatigue: motor neurons can not make Ach fast enough
  - Psychological fatigue: depends on emotional state of individual

# Causes of Muscular Fatigue

- pH has minimal role in muscle fatigue
- Depletion of stored glycogen; lack of ATP; buildup of ADP
- Muscle fatigue is partly caused by failure of SR  $\text{Ca}^{2+}$  release
  - $\text{Ca-P}_i$  precipitation in the SR could decrease the  $\text{Ca}^{2+}$  available for release
  - Caffeine to increase  $\text{Ca}^{2+}$  release from the SR
- After severe exercise, remodeling of ryanodine receptor complex causes leaky  $\text{Ca}^{2+}$  channels that cause decreased exercise tolerance

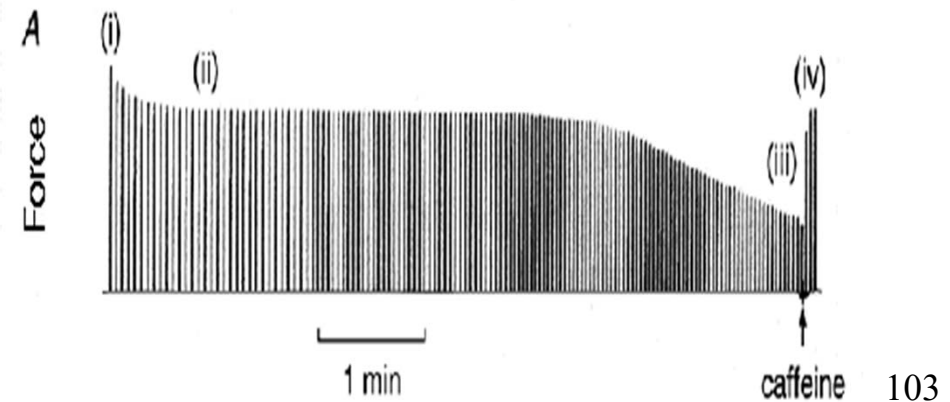
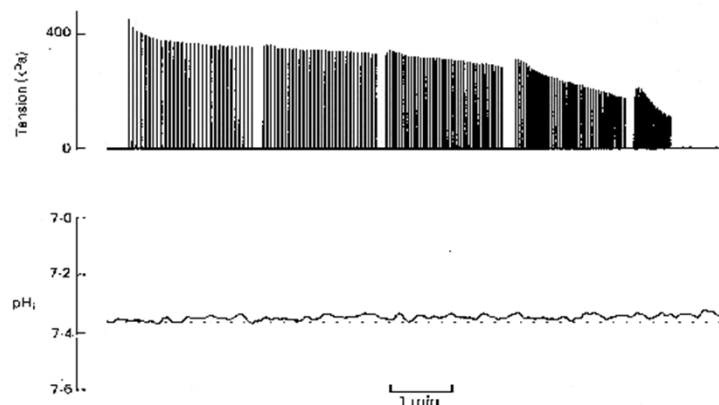

# Quiz\_16

The response of skeletal m. is always excitatory. How to inhibit the response of skeletal muscle?

- (A) Reduce the excitability of neuron
- (B) Activation of antagonist
- (C) Make muscle fatigue

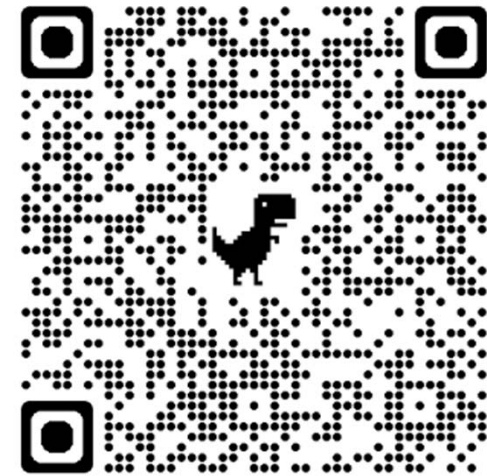



# Outlines

1. Background
2. Skeletal Muscle
  - Architecture & Structure
  - Sliding Filament Model of M. Contraction
  - Process of Skeletal M. Contraction
  - Control of Skeletal M. Contraction
  - Mechanics of Skeletal M. Contraction
  - Energetics of Skeletal M. Contraction
3. Smooth Muscle
  - Structural Characteristics
  - Smooth Muscle Contraction & Relaxation
  - Classification of Smooth Muscle
4. Cardiac Muscle

# Quiz\_17

What is the energetic fuel of skeletal muscle contraction?

- (A) ATP
- (B) ADP
- (C) AMP



<https://forms.gle/AQ29ykd2tzqz6WM8A>

# Energy for Contraction<sub>1</sub>

ATP provides energy for muscle contractions from following sources

- Cellular ATP
- Creatine phosphate: 1 ATP
  - During resting conditions stores energy to synthesize ATP
- Anaerobic respiration (Glycolysis) : 2 ATP
  - Occurs in absence of oxygen and results in breakdown of glucose to yield ATP and lactic acid
- Aerobic respiration (Oxidative phosphorylation) : 36 ATP
  - Requires oxygen and breaks down glucose to produce ATP, CO<sub>2</sub> and H<sub>2</sub>O
  - More efficient than anaerobic

# Energy for Contraction<sub>2</sub>

- Creatine phosphate
- Anaerobic respiration (Glycolysis)
- Aerobic respiration (Oxidative phosphorylation)

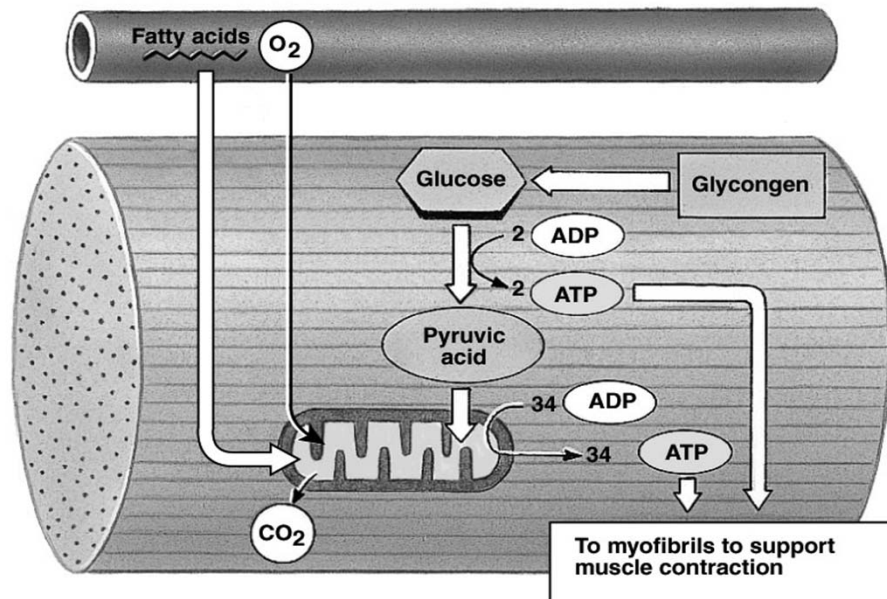
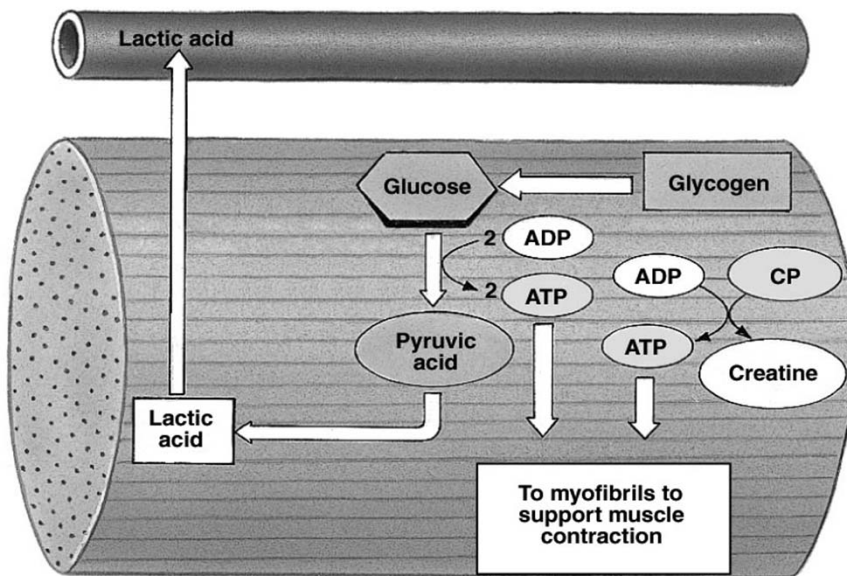

# Energy Sources in Working M.

- Stored ATP → Creatine phosphate (ATP-CP) → Glycolysis (Lactic acid sys.) → Aerobic respiration

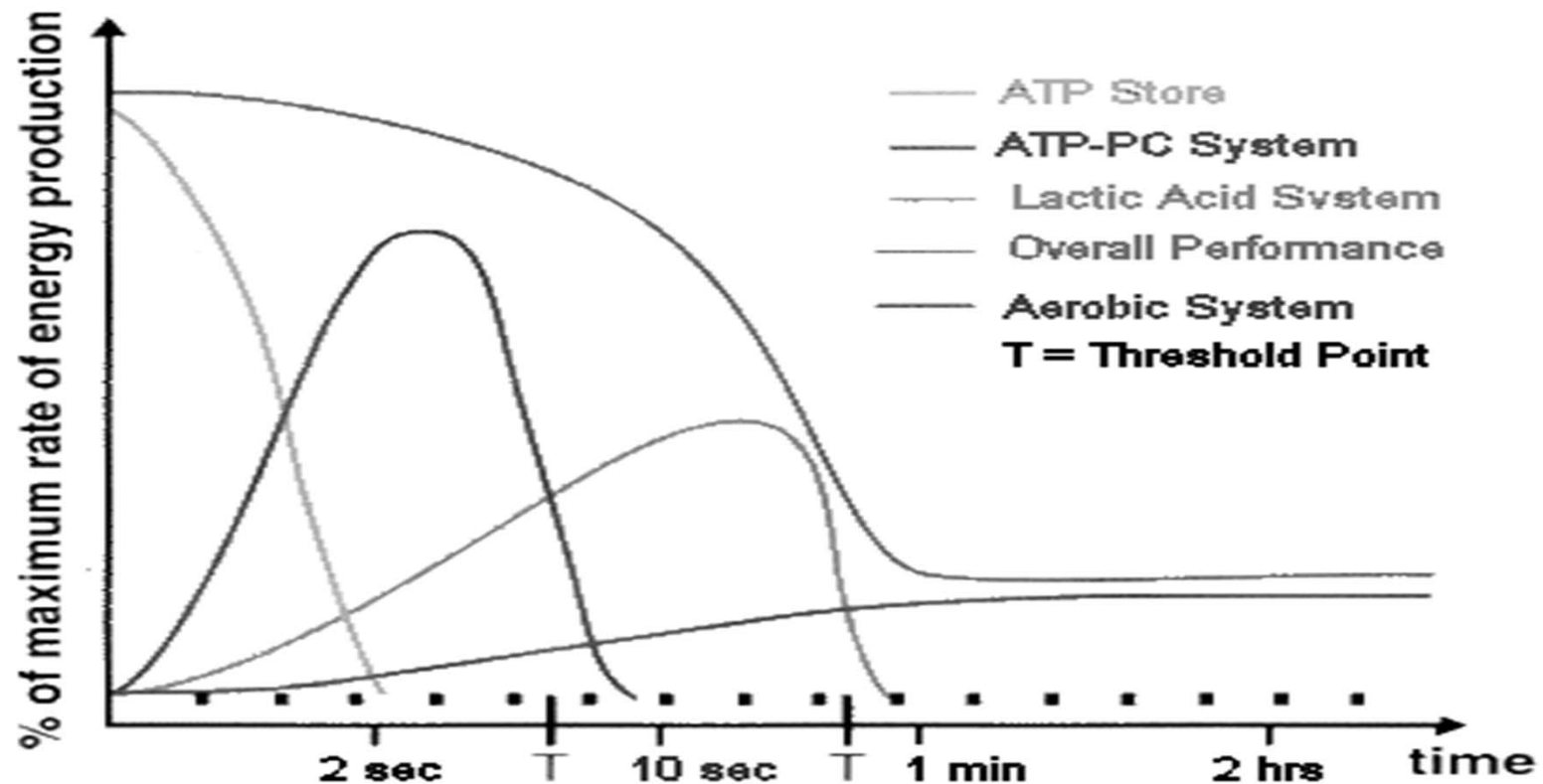

# Quiz\_18

What does ATP do for providing energy in skeletal muscle contraction?



<https://forms.gle/Se5qnHvcb9jhgRzF9>

# Functions of ATP in Skeletal-Muscle Contraction

- Binding of ATP to myosin
  - dissociates cross bridges bound to actin, allowing the bridges to repeat their cycle of activity
- Hydrolysis of ATP by myosin
  - energizes the cross bridges, providing the energy for force generation
- Hydrolysis of ATP by the Ca-ATPase in the SR
  - provides the energy for the active transport of calcium ions into the lateral sacs of the reticulum, ending the contraction

# Types of Skeletal Muscle Fiber<sub>1</sub>

- According to ATP-forming pathways
  - Oxidative fibers: use aerobic pathways
  - Glycolytic fibers: use anaerobic glycolysis
- These two criteria define three categories:
  - Slow Oxidative (SO) (type I) fibers
  - Fast Oxidative (FO) (type IIa) fibers
  - Fast Glycolytic (FG) (type IIb) fibers
- Most muscles have all three types of m. fibers
- A motor unit is composed of one type of fiber

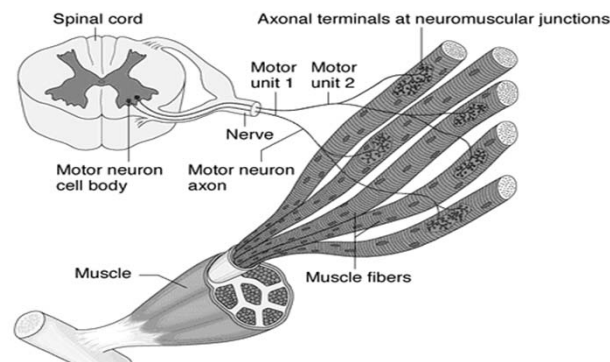



# Types of Skeletal Muscle Fiber<sub>2</sub>

- Within the same muscle:
  - Size of motor unit:  $FG > FO > SO$
  - Recruitment order:  $SO \rightarrow FO \rightarrow FG$

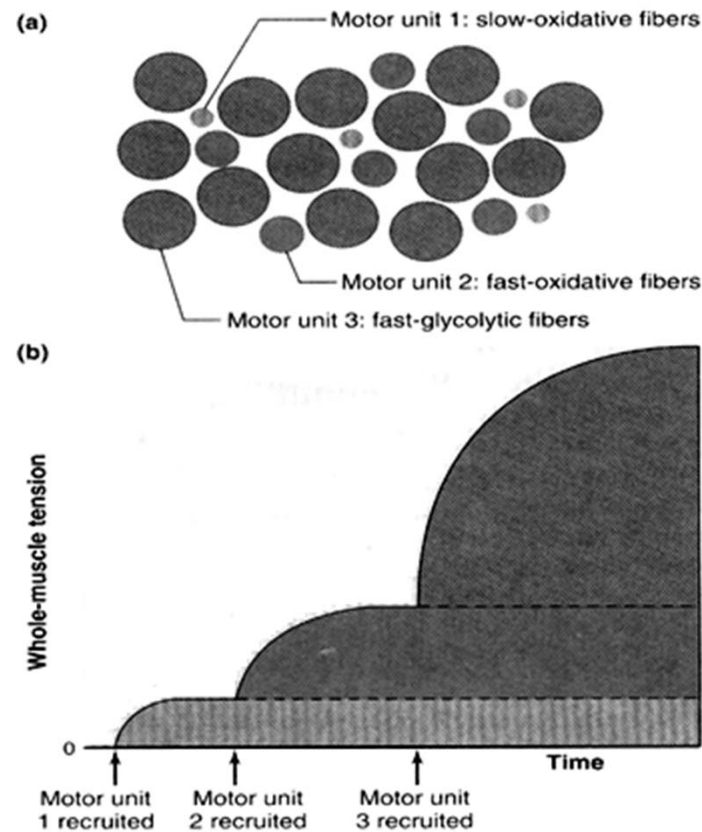

# Quiz\_19

Why can skeletal muscles be divided into red muscles and white muscles?

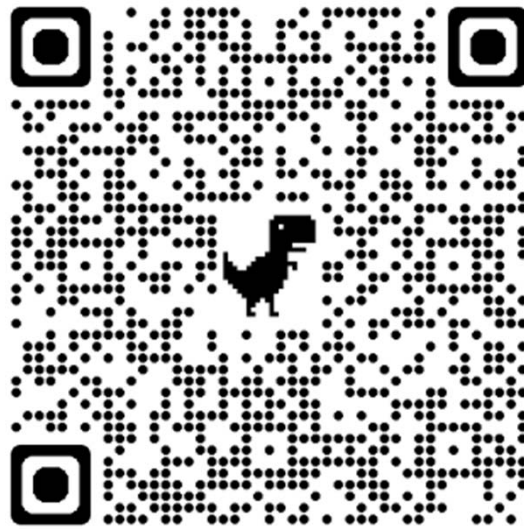

<https://forms.gle/tjQG6M6HjrRBtC1cA>

# Types of Skeletal Muscle Fiber<sub>2</sub>

	Slow Oxidative Fibers (I)	Fast Oxidative Fibers (IIa)	Fast Glycolytic Fibers (IIb)
<b>Metabolic Characteristics</b>			
Speed of contraction	Slow	Fast	Fast
Myosin ATPase activity	Slow	Fast	Fast
Primary pathway for ATP synthesis	Aerobic	Aerobic	Anaerobic
Myoglobin content	High	High	Low
Glycogen stores	Low	Intermediate	High
Recruitment order	First	Second	Third
Rate of fatigue	Slow	Intermediate	Fast
<b>Activities Best Suited For</b>	Endurance-type activities; e.g., running a marathon; maintaining posture	Sprinting, walking	Short-term intense or powerful movements, e.g., hitting a baseball
<b>Structural Characteristics</b>			
Color	Red	Red to pink	White
Fiber diameter	Small	Intermediate	Large
Mitochondria	Many	Many	Few
Capillaries	Many	Many	Few

# Exercise Training on Adaptation of Muscle Fibers

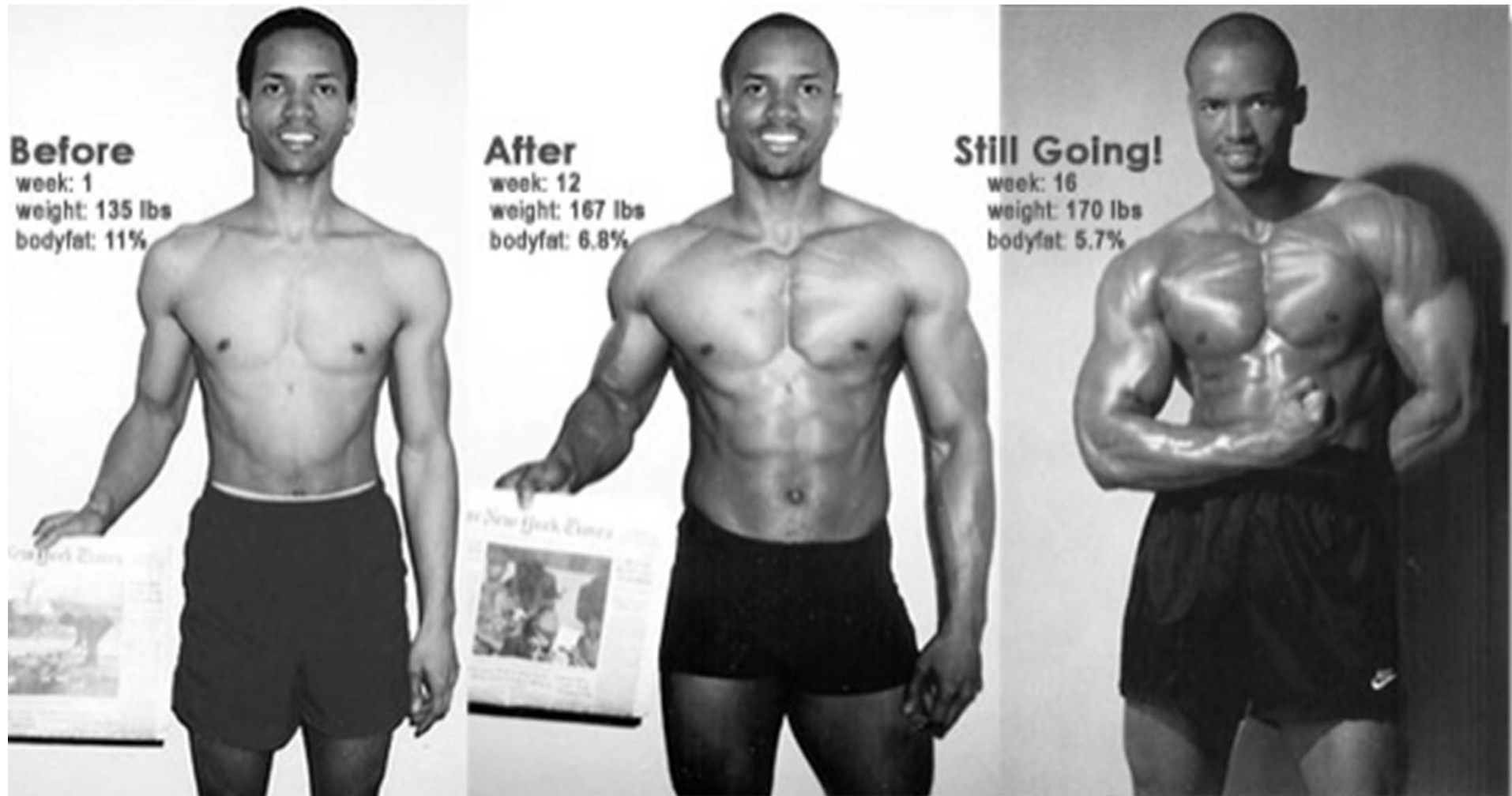

# Exercise Training on Adaptation of Muscle Fibers

- Regular endurance exercise
  - improves oxidative capacity in oxidative fibers
    - increase capillaries, mitochondria
- High-intensity resistance training
  - promotes hypertrophy of fast glycolytic fibers
    - increase diameter (more myofibrils)
    - Testosterone promotes myofibril synthesis
- The extent of training determines the interconversion of the two types of fast-twitch fibers
  - E.g., weight training can convert fast-oxidative fibers to fast-glycolytic fibers
- Fast-twitch and slow-twitch fibers are not interconvertible

# Myofascial Pain

- Pain associated with inflammation or irritation of muscle or of the fascia (connective tissue) surrounding the muscle

## Treatment

- Medications
- Trigger point injections
- Physical therapy

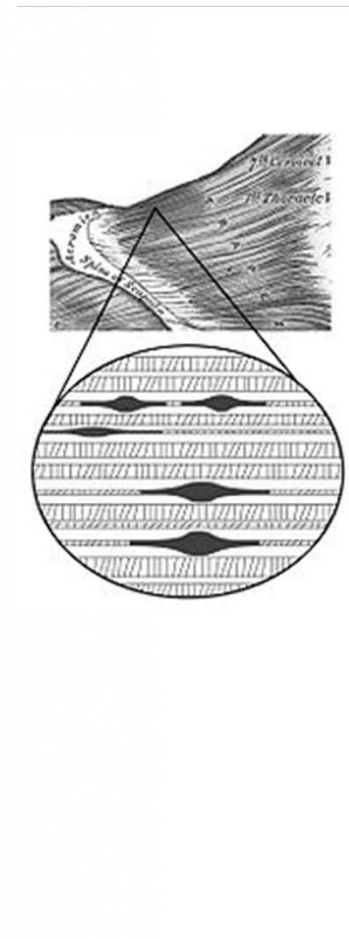
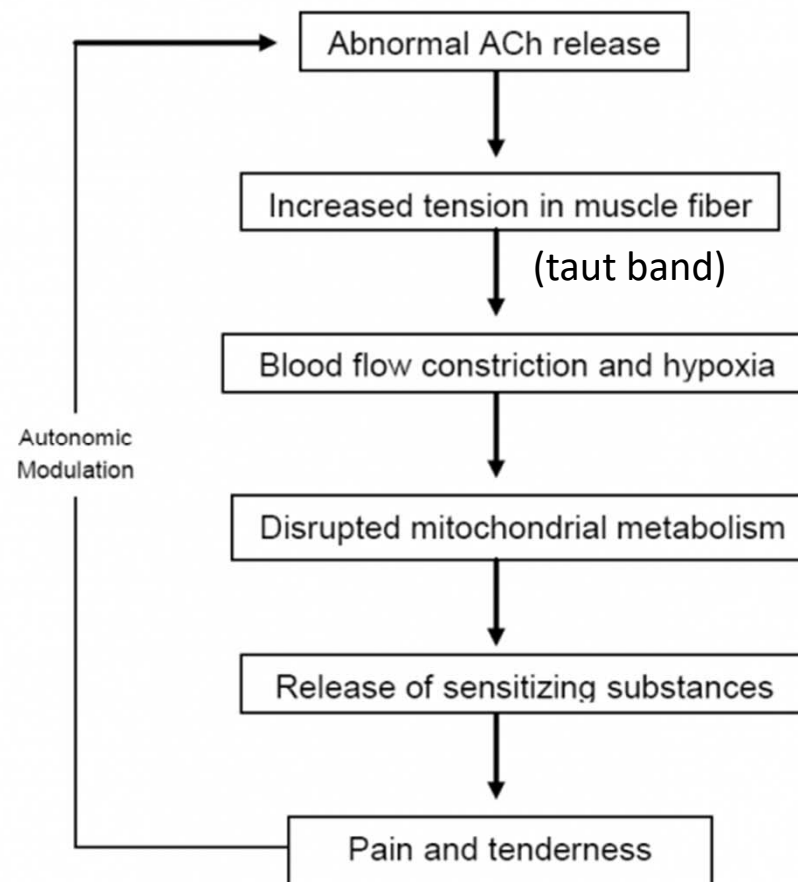

# Goals of the Lecture

- Explain the process of skeletal m. contraction
- Explain how to control skeletal m. contraction
- Interpret the mechanics of skeletal m. contraction
- Summarize the energetics of skeletal m. contraction
  
- Restate the process of smooth m. contraction and relaxation
- Classify different types of smooth m.
  
- Describe the characteristics of cardiac m.
  
- Differentiate the difference among three types of muscle

# Outlines

1. Background
2. Skeletal Muscle
  - Architecture & Structure
  - Sliding Filament Model of M. Contraction
  - Process of Skeletal M. Contraction
  - Control of Skeletal M. Contraction
  - Mechanics of Skeletal M. Contraction
  - Energetics of Skeletal M. Contraction
3. Smooth Muscle
  - Structural Characteristics
  - Smooth Muscle Contraction & Relaxation
  - Classification of Smooth Muscle
4. Cardiac Muscle



# Smooth Muscle

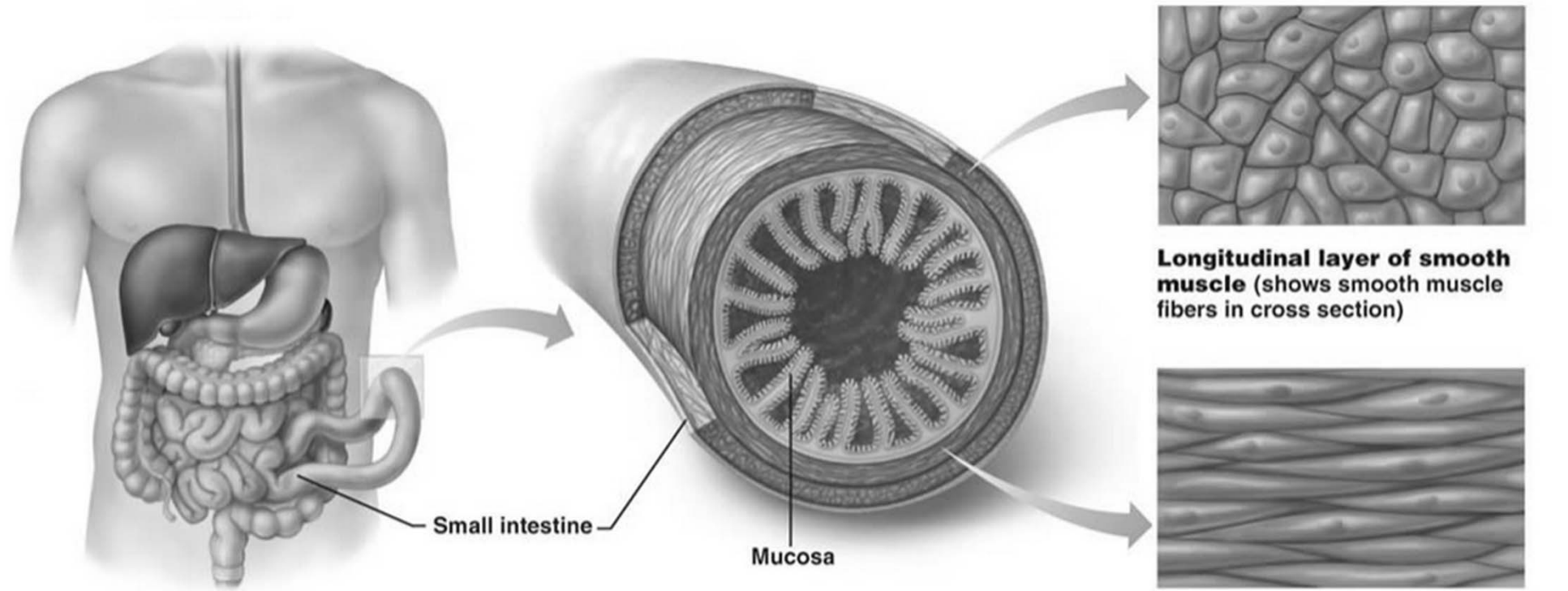

(a)

(b) Cross section of the intestine showing the smooth muscle layers (one circular and the other longitudinal) running at right angles to each other.

Longitudinal layer of smooth muscle (shows smooth muscle fibers in cross section)

Circular layer of smooth muscle (shows longitudinal views of smooth muscle fibers)

# Structural Characteristics of Smooth M<sub>1</sub>

## <Anatomical Structure>

- No sarcomeres (hence the name smooth)
- Spindle shaped cells
- A single nucleus present in the central thick portion
- Relatively small compared to skeletal and cardiac muscle
- Fewer mitochondria as compared to the skeletal muscle

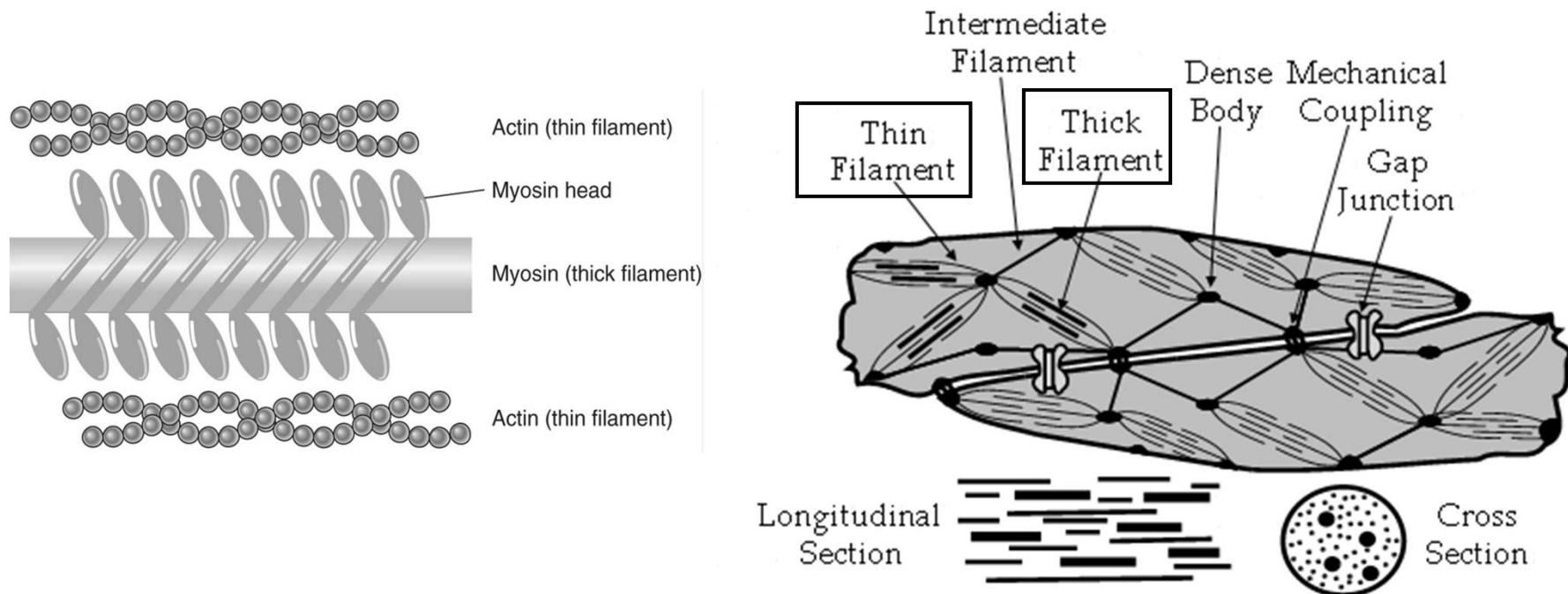

# Structural Characteristics of Smooth M<sub>2</sub>

## Actin (thin-filament)

- No troponin present at all
- Tropomyosin present in smooth muscle actin but exact functional role unclear

## Myosin (thick filament)

- Myosin light chains play a key regulatory role in smooth muscle
- Lack neat hexagonal arrangement of actin and myosin
- Actin/myosin ratio: greater in smooth muscle (10:1) than in skeletal muscle (2:1)

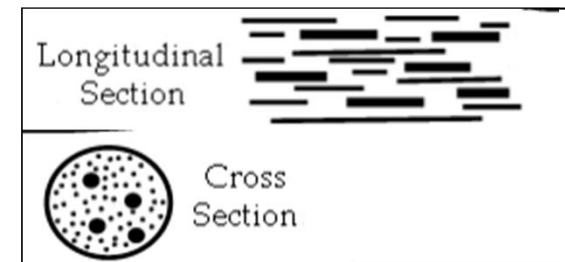

# Structural Characteristics of Smooth M<sub>3</sub>

## Intermediate filaments

- Cytoskeletal elements which form a structural backbone against which contraction occurs

## Dense bodies

- Serve as anchors for the thin-filament actin
- Analogous to Z-lines in striated muscle

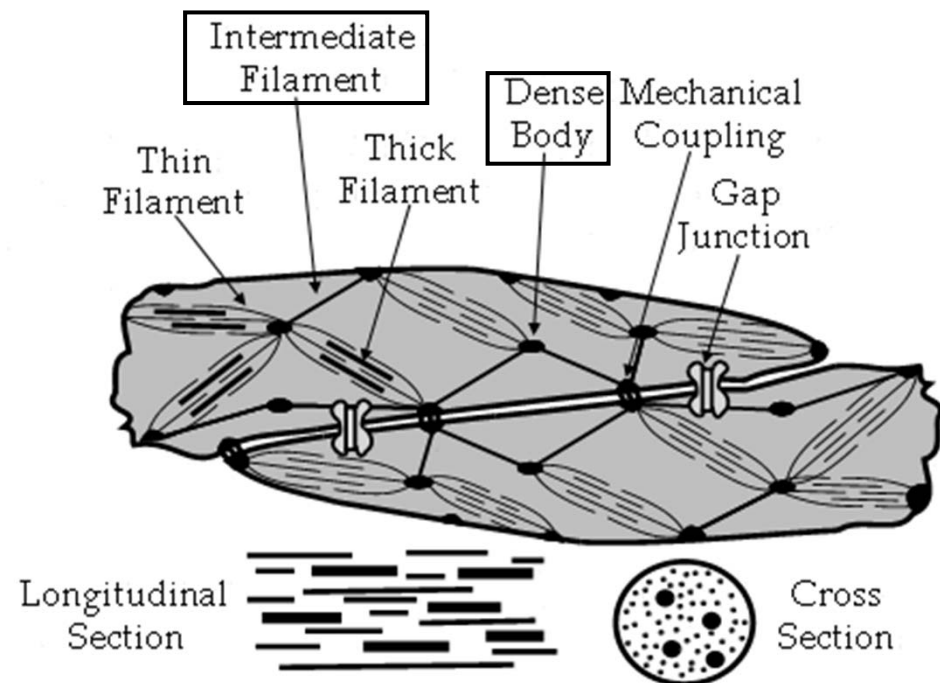

# Structural Characteristics of Smooth M<sub>4</sub>

## <Innervation & Conduction>

- Innervated by the autonomic nervous system (symp. & parasymp. n.)
- No specialized nerve-muscle junction in single unit smooth m.
- No T-tubules and no terminal cistern system
  - Multiunit smooth muscle does not require action potential to contract
- Poorly developed sarcoplasmic reticulum
  - Needs extracellular Ca<sup>2+</sup> source for contraction

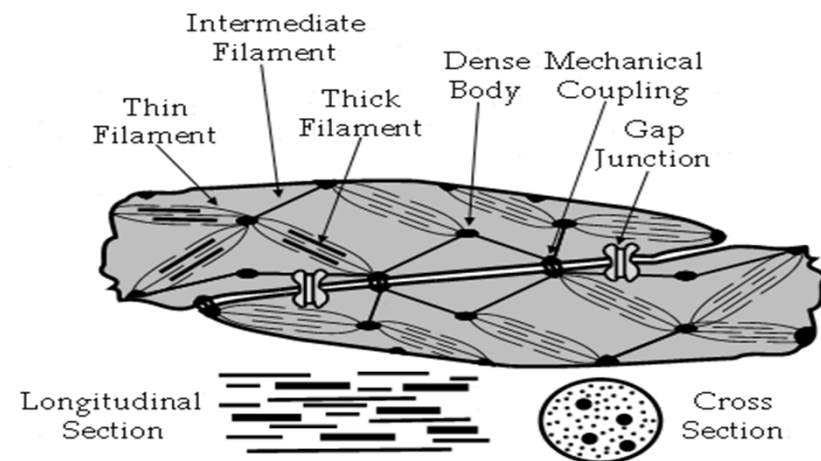

# Structural Characteristics of Smooth M<sub>5</sub>

## Gap Junctions

- Allow direct electrical communications between adjacent smooth muscle cells
- Gap junction density varies from tissue to tissue

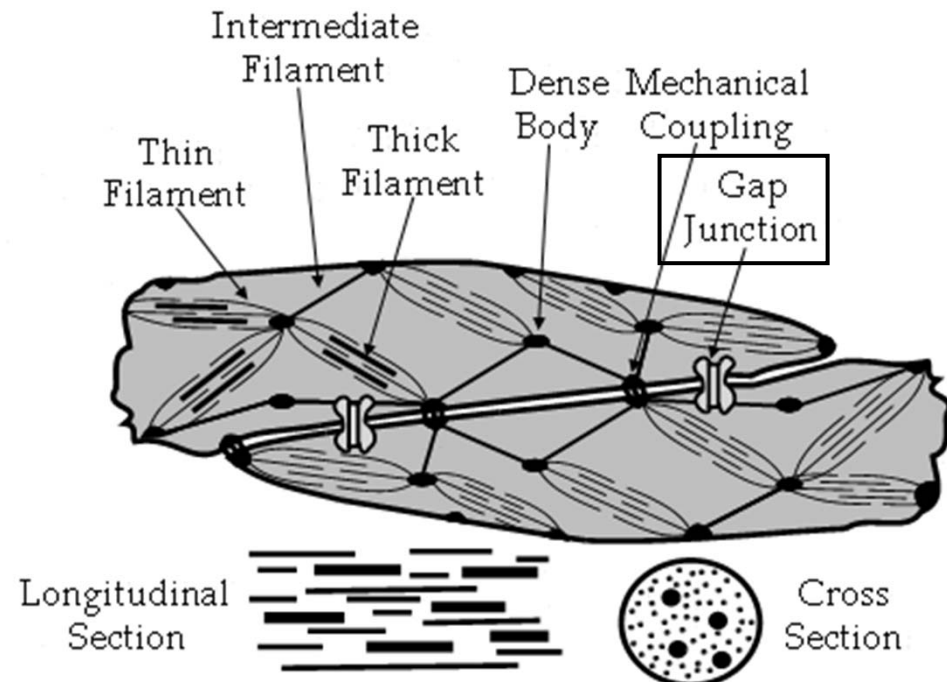

# Voltage-Gated Channels in Smooth M.

- Smooth muscle has relatively few of the voltage-gated (fast) Na<sup>+</sup> channels
- Major depolarizing current carried by Ca<sup>2+</sup> channels
  - L-type (long acting)
    - Open slowly and close slowly
    - Affected by Ca<sup>2+</sup>-channel blockers
  - T-type (transient)
    - Open and close quickly
    - Not blocked by Ca<sup>2+</sup> channel blockers
    - Rapid influx → Ca<sup>2+</sup>-induced Ca<sup>2+</sup> release from the SR

# Outlines

1. Background
2. Skeletal Muscle
  - Architecture & Structure
  - Sliding Filament Model of M. Contraction
  - Process of Skeletal M. Contraction
  - Control of Skeletal M. Contraction
  - Mechanics of Skeletal M. Contraction
  - Energetics of Skeletal M. Contraction
3. Smooth Muscle
  - Structural Characteristics
  - Smooth Muscle Contraction & Relaxation
  - Classification of Smooth Muscle
4. Cardiac Muscle



# Single Muscle Twitch

- Single muscle contraction (muscle twitch) develops more slowly & relaxes even more slowly
  - longer sustained contraction without fatigue
- A typical smooth muscle contraction is about 30 times longer than single skeletal muscle contraction
- Advantage: allows the walls of organs to maintain tension with a continued load .e.g. urinary bladder filled with urine

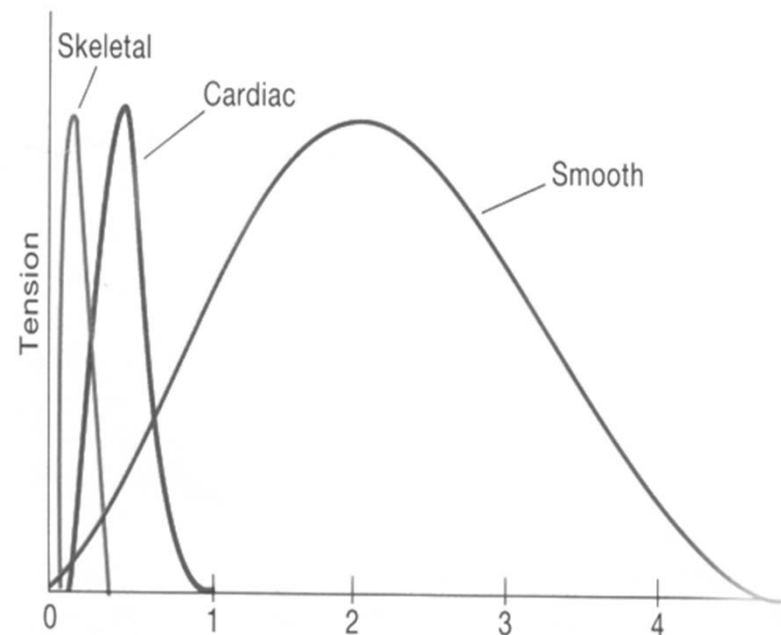

# Smooth Muscle Contraction

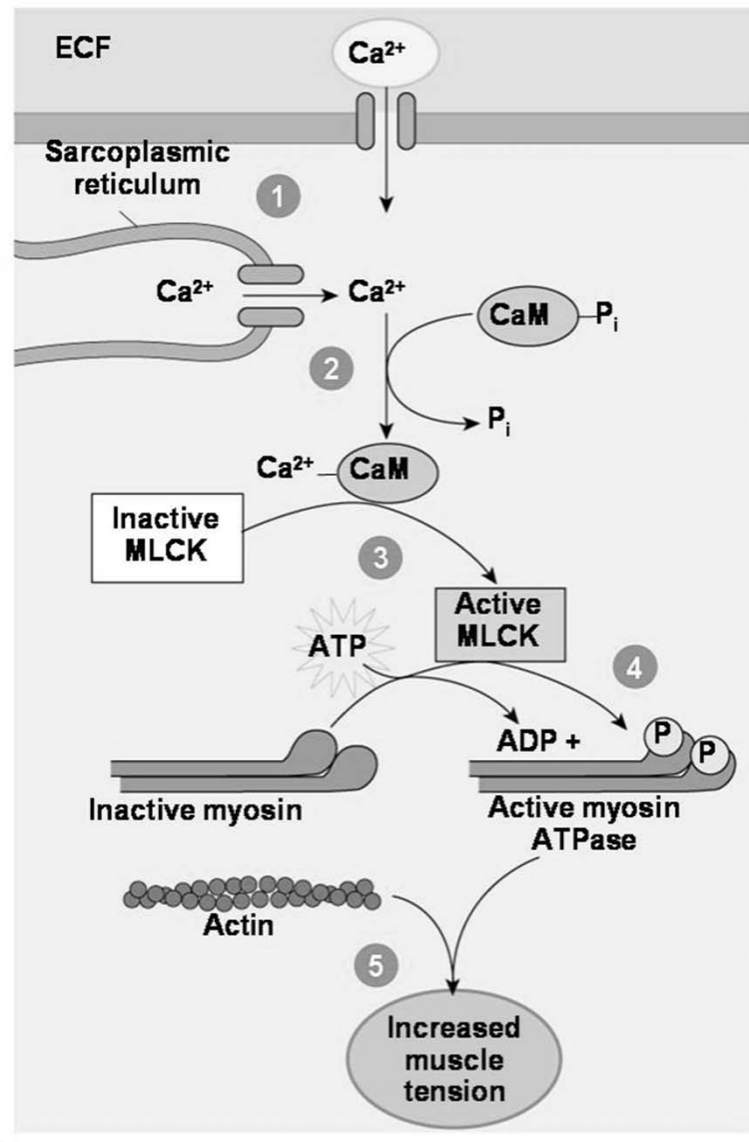

1. Excitatory stimulus leads to rise in intracellular  $[Ca^{2+}]$ 
  - Entry through membrane calcium channels
  - Release of calcium from SR intracellular stores
2. Calcium binds to calmodulin (CaM; CALcium MODULated proteIN)
3. Calmodulin Complex activates the Myosin Light Chain Kinase (MLCK)
4. MLCK phosphorylates the myosin light chains
5. Myosin can begin to cycle and attach to actin

# Mechanisms of Smooth M. Relaxation<sub>1</sub>

1. Lower intracellular  $[Ca^{2+}]$ 
  - Calcium extrusion from the cell
    - $3Na^+/Ca^{2+}$  exchanger
  - Reuptake by the sarcoplasmic reticulum
    - SR  $Ca^{2+}$  ATPase

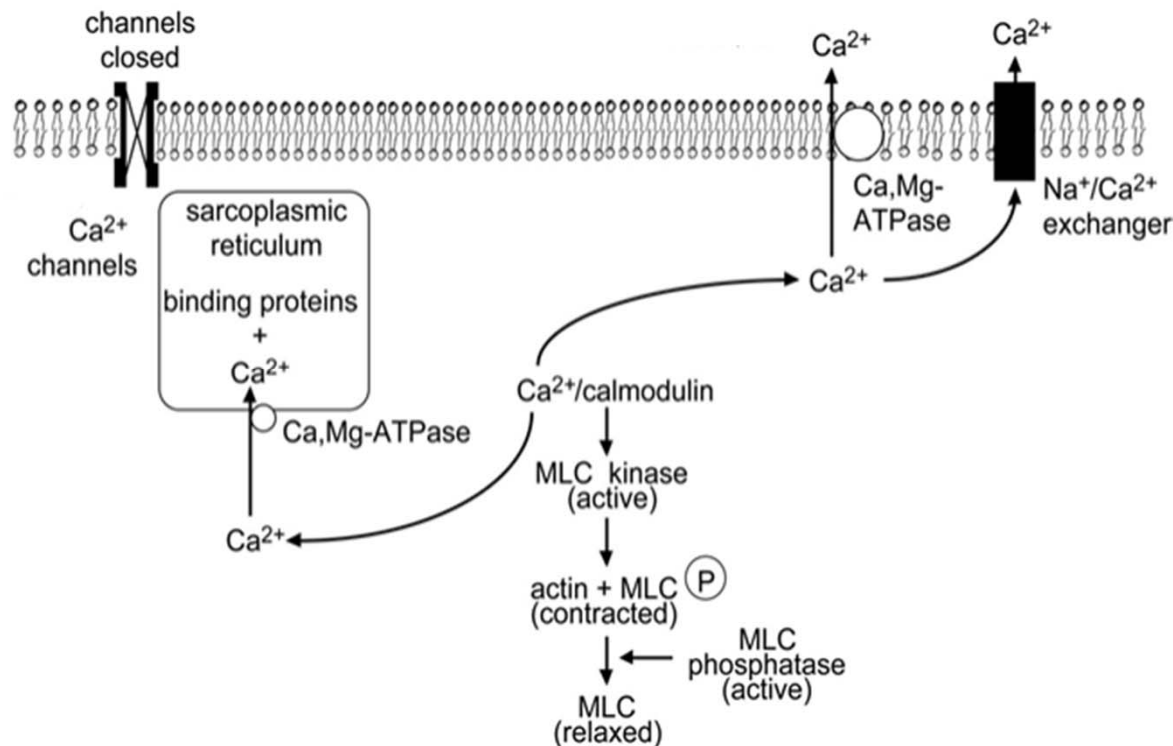

# Mechanisms of Smooth M. Relaxation<sub>2</sub>

2. PKA reduces the affinity between MLCK and CaCM
  - Epinephrine binding to  $\beta$ -adrenergic receptors raises cAMP
  - cAMP activates protein kinase A (PKA)
  - PKA phosphorylates the MLCK
  - p-MLCK is inactivated and reduces its affinity to CaCM
3. Phosphatases remove the phosphate from myosin light chains

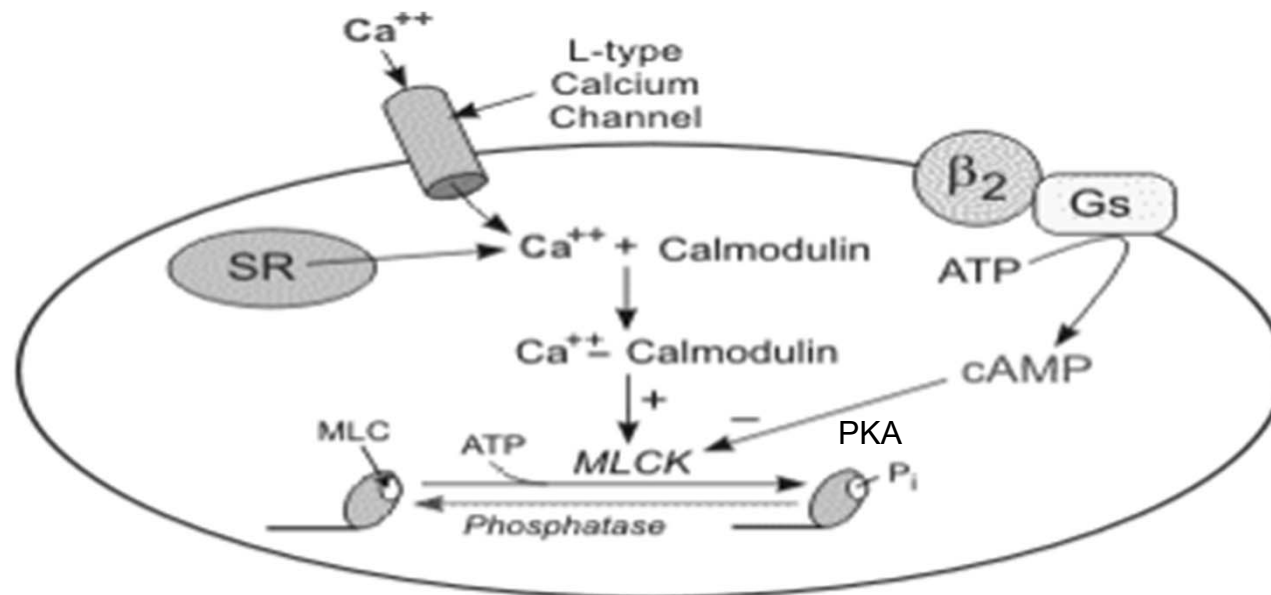

Abbreviations: SR, sarcoplasmic reticulum; Gq, Gs-protein; MLC, myosin light chain; MLCK, myosin light chain kinase; Pi, myosin phosphorylation

# Smooth M. Latch State

- A special state that allows smooth muscle to maintain tone (force) with minimal expenditure of ATP
- Before power stroke, myosin is de-phosphorylated; Shortening is not occurring
- Economy is high because the ATP use is slow to maintain force in the absence of external work

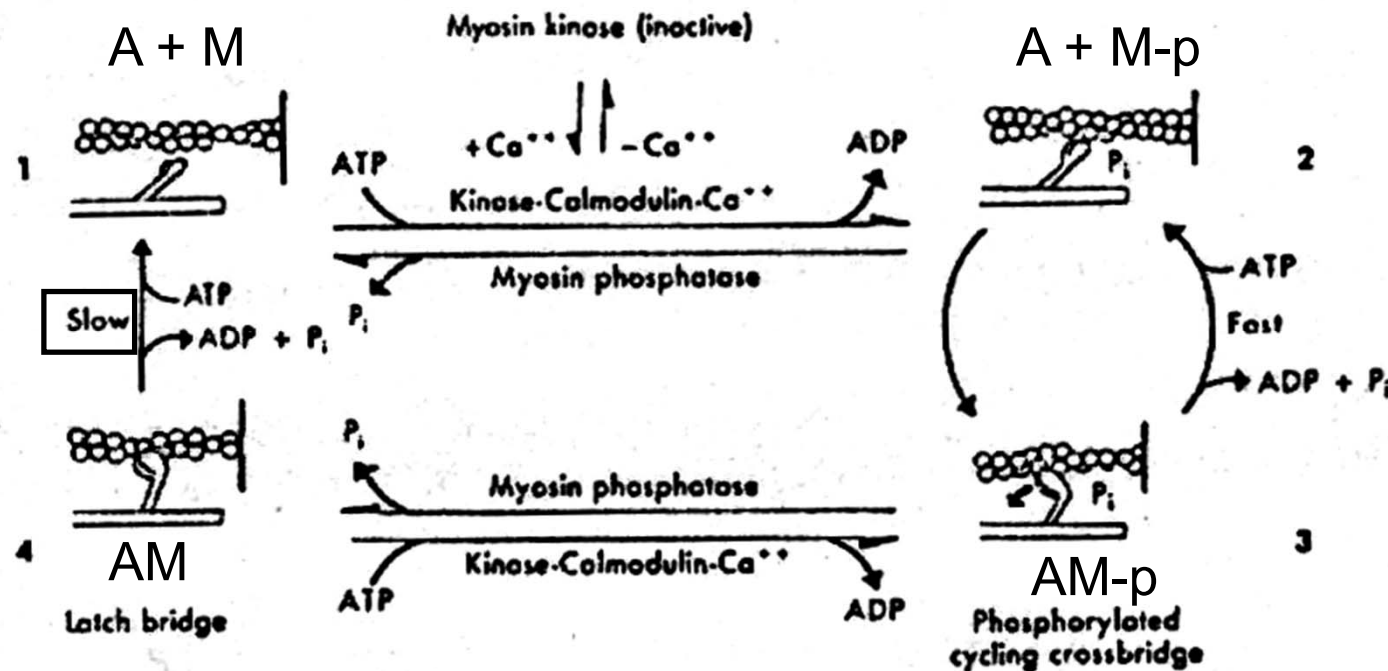

# Unique Mechanical Properties

- Slow shortening velocity
  - Slow actomyosin ATPase (i.e. slow cross bridge cycle)
- Max shortening velocities and active stress are proportion of phosphorylation
- High economy of energy utilization during isometric contraction (latch state)

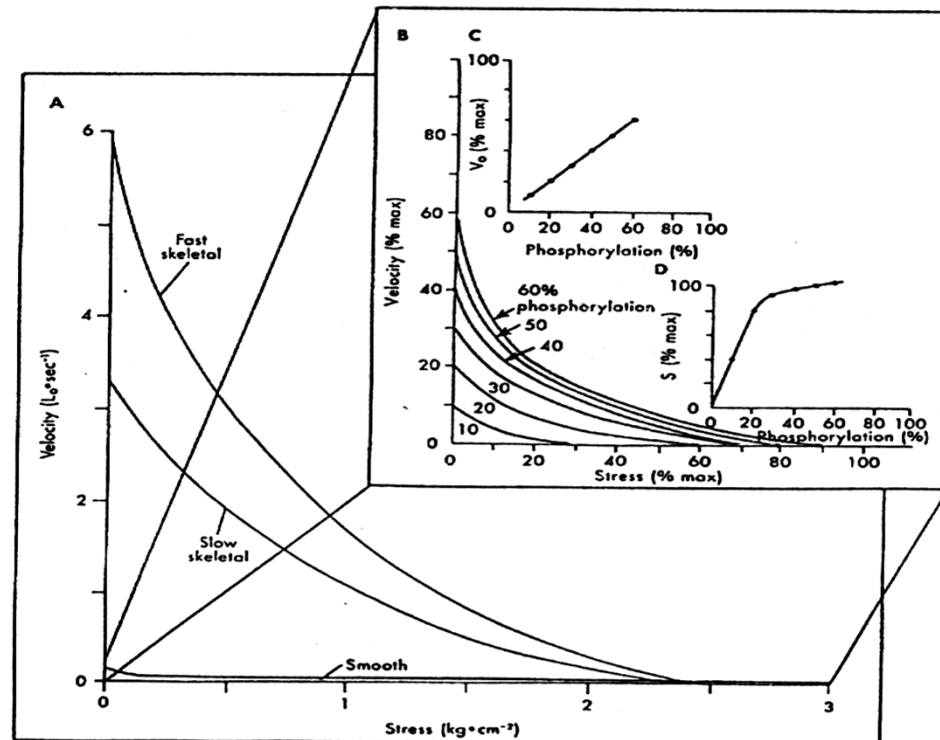

# Difference in Contraction Mechanism Between Smooth M. & Striated M.

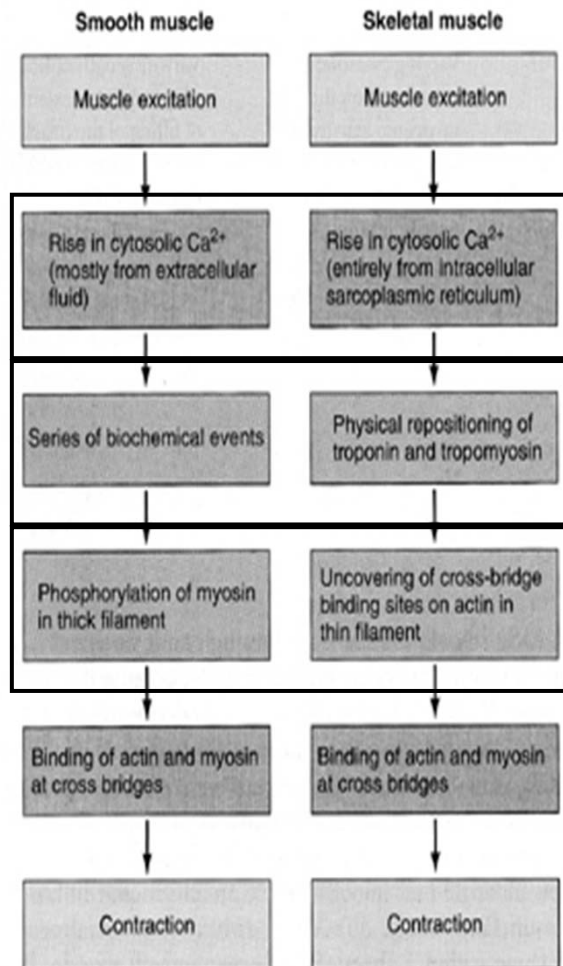

- Smooth m.

- $Ca^{2+}$  from extracellular space and SR
- Covalent regulation: Ca-calmodulin-MLCK phosphorylates myosin
- Thick filament regulation: myosin-based

- Striated m. (skeletal m. & cardiac m.)

- $Ca^{2+}$  from SR only
- Allosteric regulation:  $Ca^{2+}$  binds TnC  $\rightarrow$  tropomyosin moves  $\rightarrow$  myosin binding site is exposed
- Thin filament regulation: actin-tropomyosin-troponin complex-based

# Outlines

1. Background
2. Skeletal Muscle
  - Architecture & Structure
  - Sliding Filament Model of M. Contraction
  - Process of Skeletal M. Contraction
  - Control of Skeletal M. Contraction
  - Mechanics of Skeletal M. Contraction
  - Energetics of Skeletal M. Contraction
3. Smooth Muscle
  - Structural Characteristics
  - Smooth Muscle Contraction & Relaxation
  - Classification of Smooth Muscle
4. Cardiac Muscle



# Classification of Smooth Muscle

Types of smooth muscle:

- Single unit (visceral or unitary): common
  - Function as a unit
- Multiunit: rare
  - Cells or groups of cells act as independent units

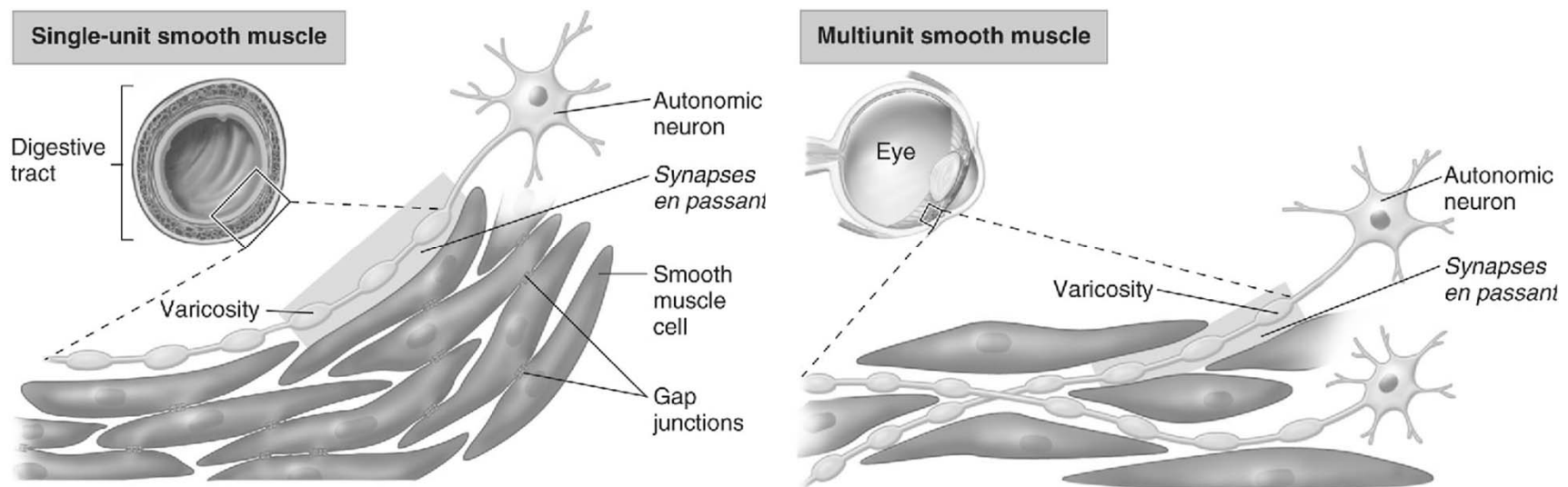

# Single-Unit Smooth Muscle<sub>1</sub>

- Behave in a synchronic manner, much like cardiac muscle
- Function as a single unit and contract together
  - When an AP develops in one cell, depolarization quickly spreads to other cells
- Link by gap junctions
- Example:
  - Small intestine
  - Urinary bladder
  - Uterus
  - Smaller arteriole
  - Lymph vessels

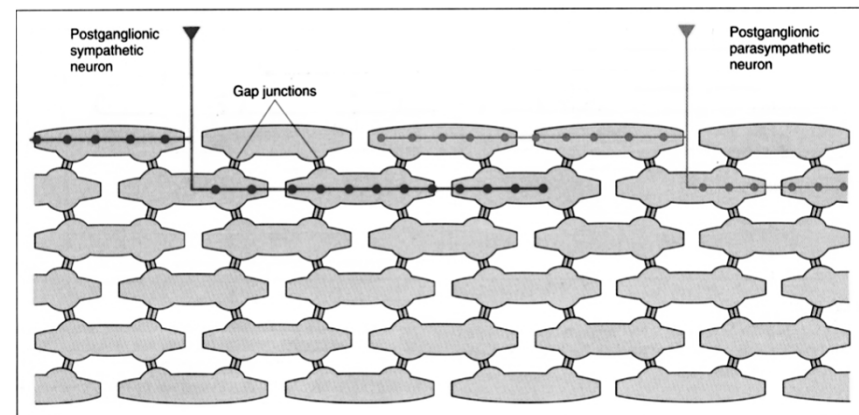

# Single-Unit Smooth Muscle<sub>2</sub>

- Electrical Characteristics: stimulated by both neurogenic and myogenic activity
  1. Neurogenic activity: autonomic nervous system
    - Relatively sparse innervation
  2. Myogenic activity (muscle produced)
    - Pacemaker activity (e.g., lymph vessels)
      - Automatic changes in channel permeability
      - Action potential spread to nonpacemaker cell
    - Slow wave potential (e.g., intestine)
      - Na<sup>+</sup> is actively transported across membrane
      - Threshold not always reached, but when it is, a burst of AP's follow

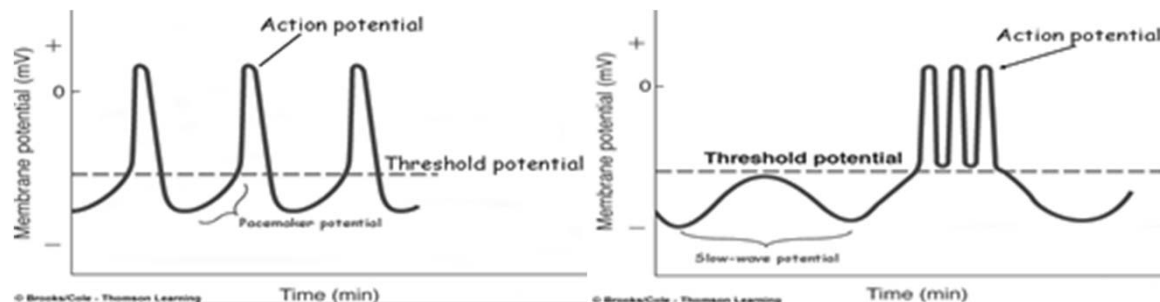

# Single-Unit Smooth Muscle<sub>3</sub>

- Mechanical Characteristics
  - Plasticity (also called “stress relaxation”)
    - Slow stretch → lengthening
    - e.g. bladder capacity w/o pressure increase
  - Stretch induced contraction
    - Fast stretch causes depolarization and leads to contraction
- Contraction is influenced by the nervous system and endocrine system

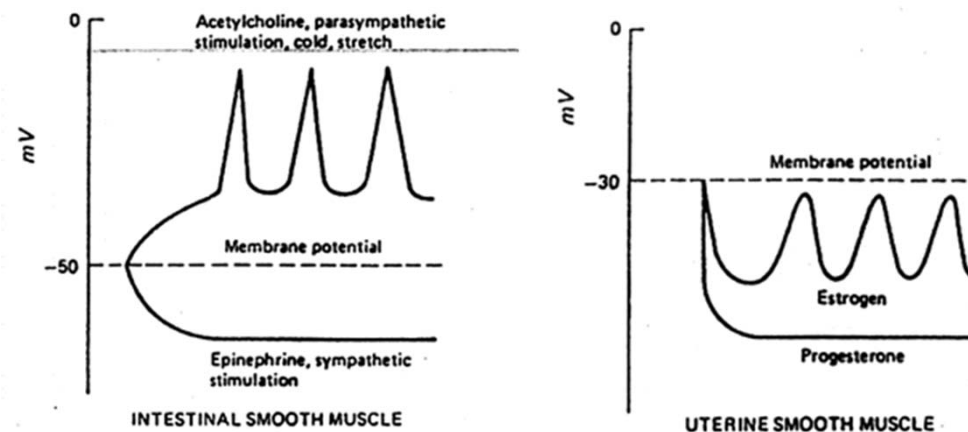

# Multiunit Smooth Muscle<sub>1</sub>

- Each smooth muscle cell acts independently (like skeletal muscle)
- Less gap junctions between cells
- Example:
  - Large blood vessels
  - Tracheal muscle & bronchial muscle
  - Iris muscle
  - Base of hair follicles (goose bumps)

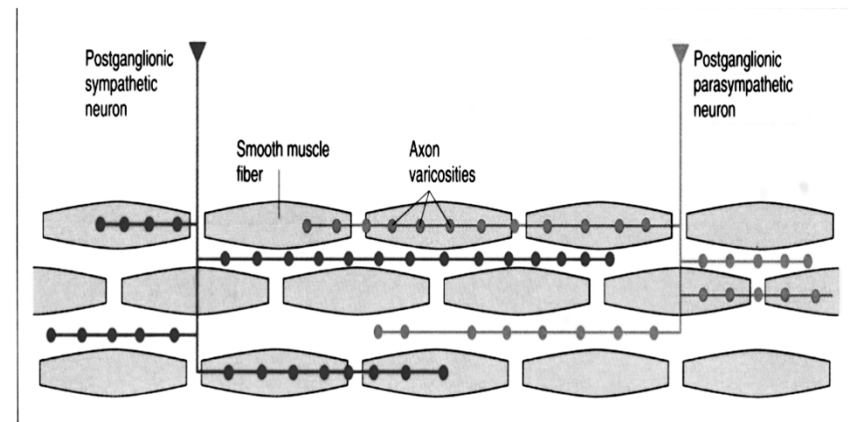

# Multiunit Smooth Muscle<sub>2</sub>

- Each unit is separately stimulated by nerves of autonomic nervous system
  - Higher innervation ratios than visceral smooth muscle
- Electrical Characteristics: no myogenic activity
  - Membrane potential of multiunit smooth muscle is stable
  - Graded depolarization
  - Typically, do not display action potentials when stimulated to contract
- Mechanical Characteristics
  - No inherent response to stretch

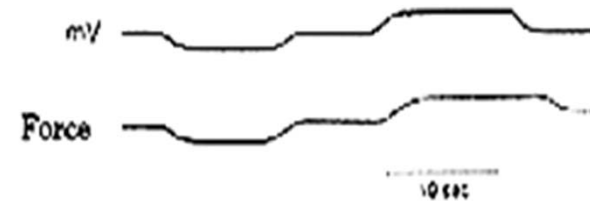

# Goals of the Lecture

- Explain the process of skeletal m. contraction
- Explain how to control skeletal m. contraction
- Interpret the mechanics of skeletal m. contraction
- Summarize the energetics of skeletal m. contraction
  
- Restate the process of smooth m. contraction and relaxation
- Classify different types of smooth m.
  
- Describe the characteristics of cardiac m.
  
- Differentiate the difference among three types of muscle

# Outlines

1. Background
2. Skeletal Muscle
  - Architecture & Structure
  - Sliding Filament Model of M. Contraction
  - Process of Skeletal M. Contraction
  - Control of Skeletal M. Contraction
  - Mechanics of Skeletal M. Contraction
  - Energetics of Skeletal M. Contraction
3. Smooth Muscle
  - Structural Characteristics
  - Smooth Muscle Contraction & Relaxation
  - Classification of Smooth Muscle
4. Cardiac Muscle



# Cardiac Muscle

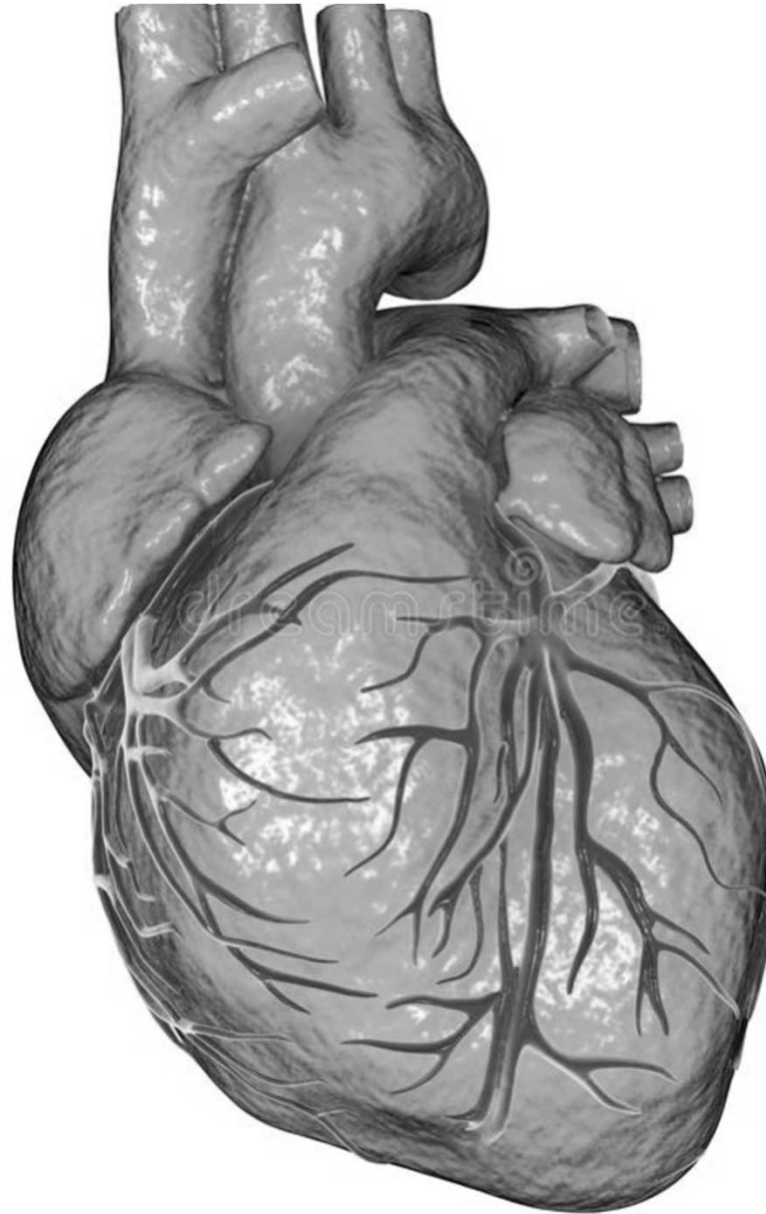

# Cardiac Muscle

- Autorhythmic cells
  - Do not contract
  - Initiate and conduct action potentials
  - No resting potential; neural input not necessary to initiate an action potential
  - Pacemaker activity instead: slow depolarization, drift to threshold, then firing
- Contractile cells
  - Do not initiate their own action potentials
  - Pump heart

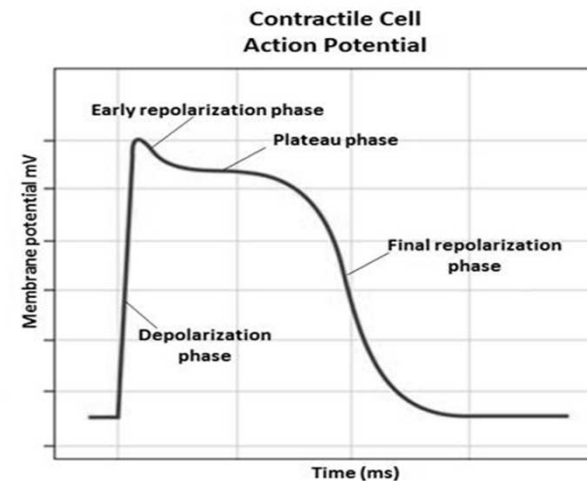
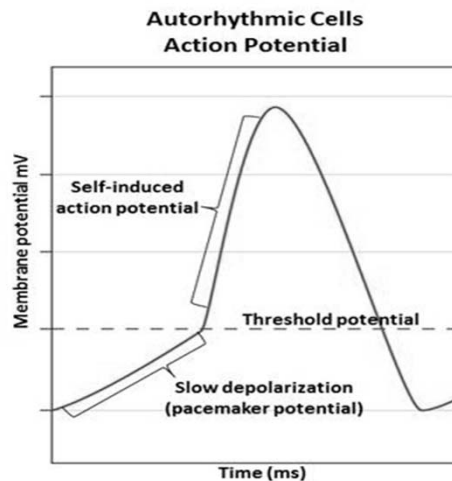

# Characteristics of the Cardiac M.

- Autorhythmic cells
  - Automaticity: cells can depolarize without any impulse from outside source (self-excitation) (Chronotropic effect)
- Conductivity: cells can propagate the electrical impulse from cell to another (Dromotropic effect)
- Contractile cells
  - Excitability: cells can respond to an electrical stimulus: (Bathmotropic effect)
  - Contractility: the specialized ability of the cardiac muscle cells to contract; contractile cells (Inotropic effect)

# Automaticity (Chronotropic effect)

- Excitatory cells
  - Similarities to single-unit smooth muscle: It can generate action potentials which spread throughout the walls of the heart
  - Sinoatrial (SA) node (in wall of Right Atrium)
    - Contains pacemaker cells
    - Sets heart rate: 70/min

## Action Potential of autorythmic cells

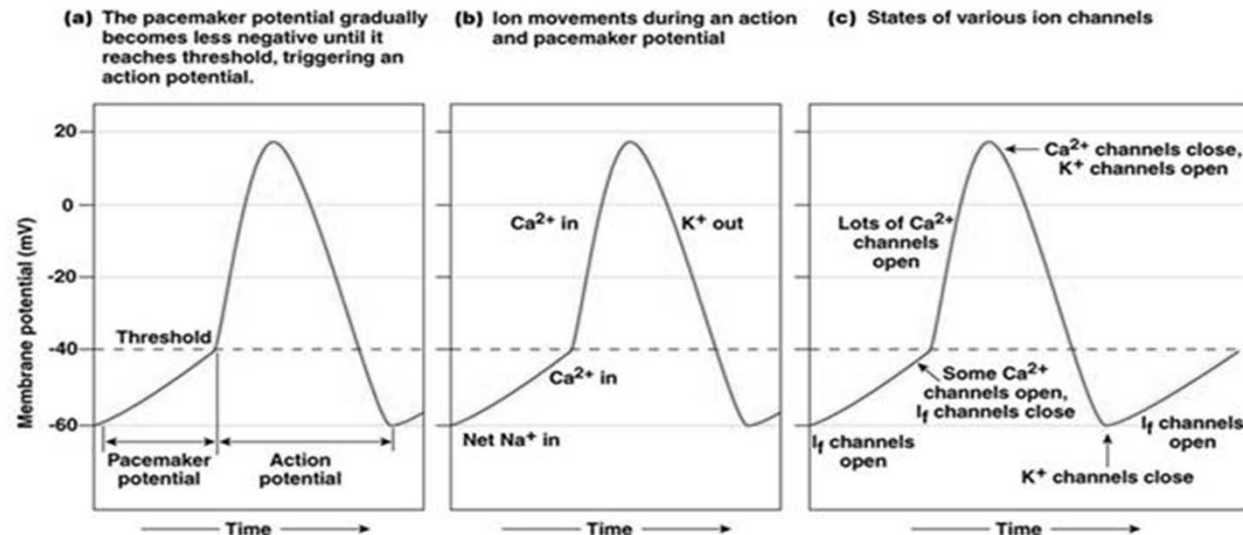

# Conductivity (Dromotropic effect)

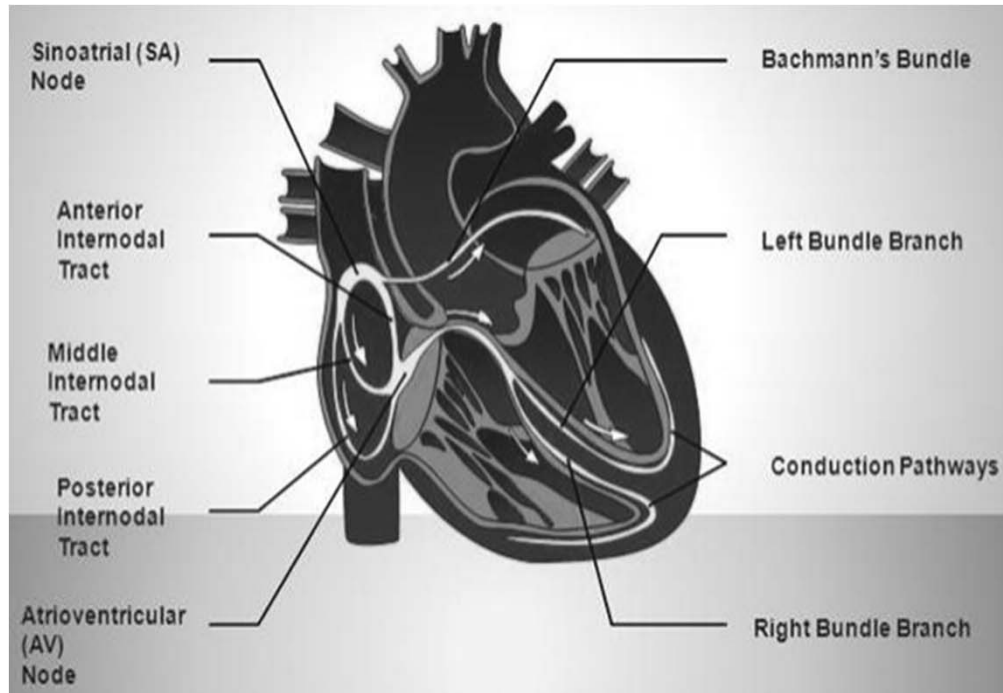

## Cells of conducting system

- SA node (in RA)
- Bachmann's bundle to LA
- Transatrial Pathways (3 internodal tracts)
- AV node (between atria and ventricles) (0.1 sec delay)
- Bundle of His (only path to ventricles)
- R & L Bundle branches
- Purkinje fibers (to ventricular myocardium)

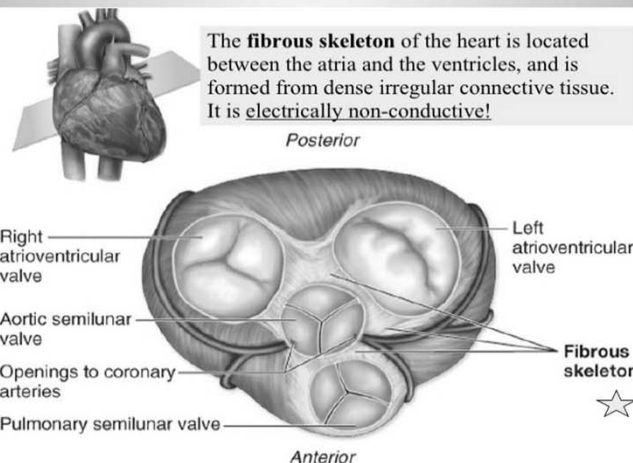

# Excitability (Bathmotropic effect)

Action Potentials of contractile cardiac cells

- Phase 0: Rapid depolarization ( $\text{Na}^+$  channels open,  $\text{Na}^+$  in)
- Phase 1: Rapid, partial early repolarization ( $\text{Na}^+$  channels close)
- Phase 2: Prolonged period of slow repolarization ( $\text{Ca}^{2+}$  channels open,  $\text{Ca}^{2+}$  in; fast  $\text{K}^+$  channels open,  $\text{K}^+$  out)
- Phase 3: Rapid final repolarization phase ( $\text{Ca}^{2+}$  channels close; slow  $\text{K}^+$  channels open,  $\text{K}^+$  out)
- Phase 4: Resting potential

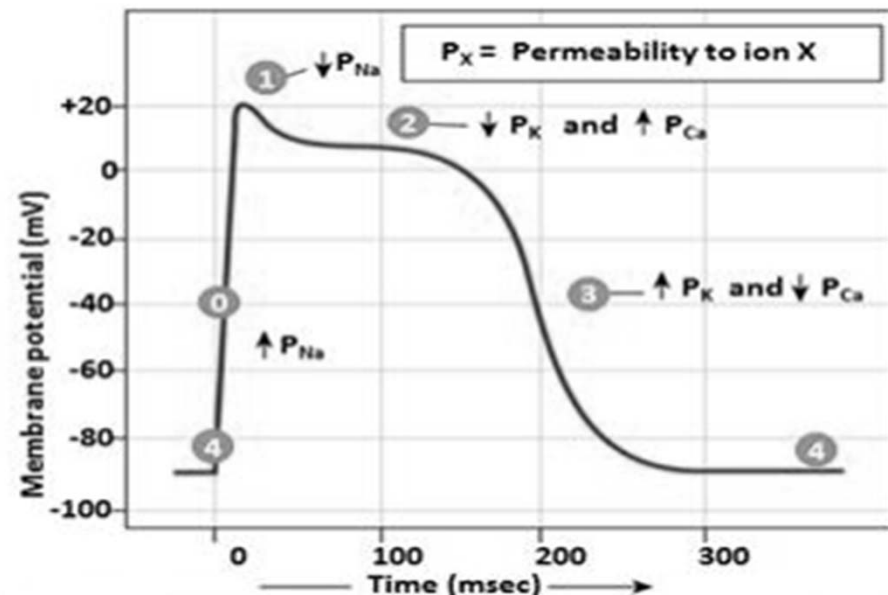

# Excitability

The refractory period lasts almost as long as the entire muscle twitch

- No summation
- No tetanus

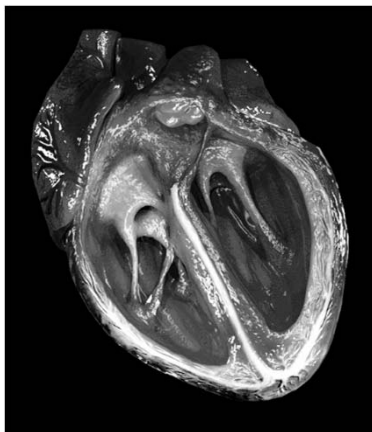
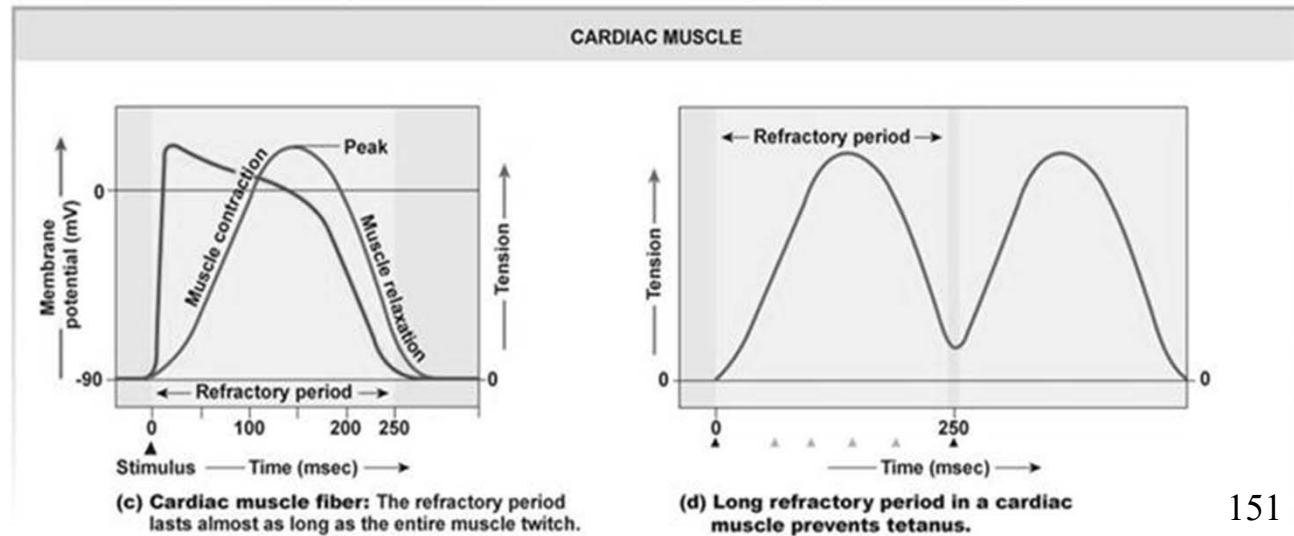
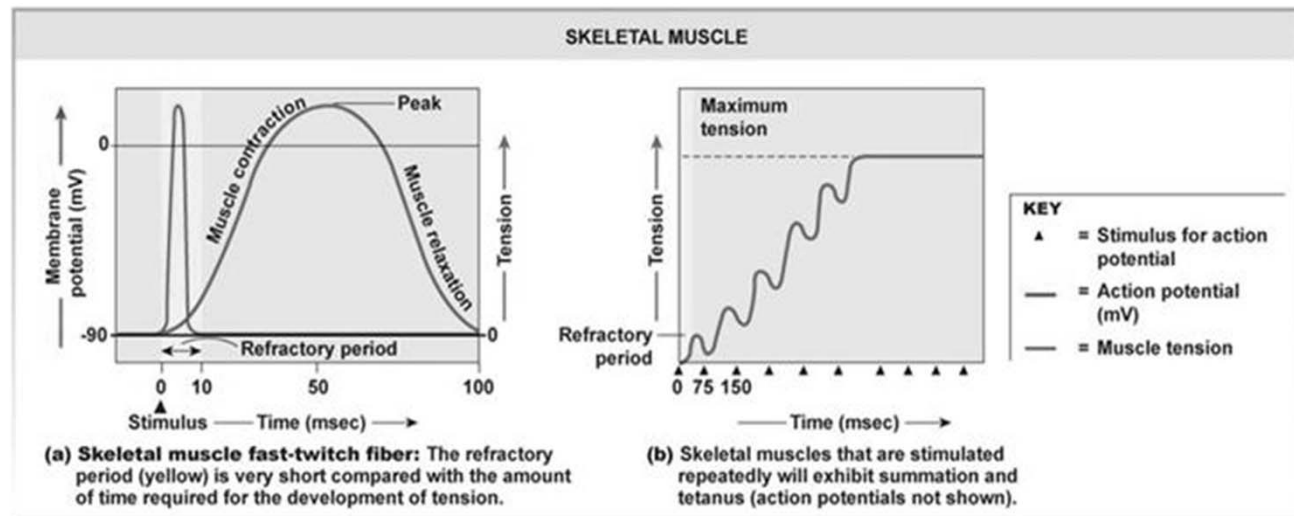

# Contractility (Inotropic effect)

- Contractile cells
  - Similarities to skeletal muscle: highly organized and striated
  - Intercalated discs
    - Desmosomes: transfer force
    - Gap junctions: allow electrical signals to pass rapidly
  - Many mitochondria
  - Large T tubes:  
located at Z disc

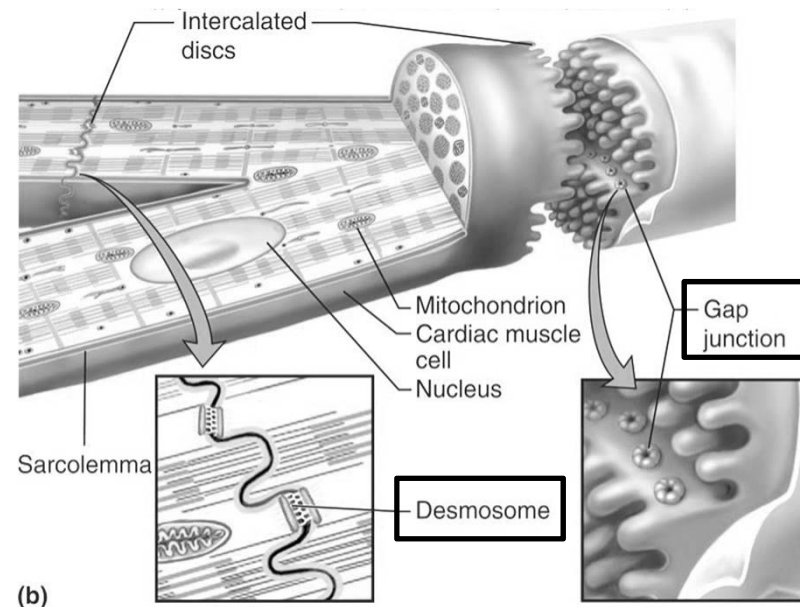
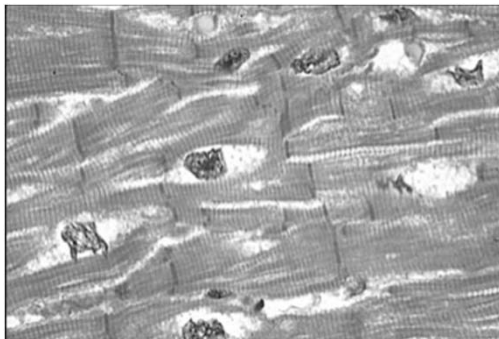



# Contractility

## Factors that affect cardiac contractility

- Mechanical factor
  - Preload (venous return): the load determines the initial length of the resting muscle before contraction
    - Represented by the end-diastolic volume (EDV), i.e. venous return
    - Frank-Starling law: venous return  $\uparrow \rightarrow$  EDV  $\uparrow \rightarrow$  strength of ventricular contraction  $\uparrow \rightarrow$  stroke volume  $\uparrow$
  - Afterload: the load muscle faces when it begins to contract, which is determined by
    - Aortic pressure
    - Arterial wall rigidity
    - Blood viscosity

# Contractility

- Cardiac factor
  - Myocardial mass: a significant injury or loss of the functioning ventricular muscle (e.g. ischemia or necrosis) decreases the force of myocardial contractility (negative inotropic effect)
  - Heart rate: the force of cardiac contractility is affected by the frequency of stimulation
    - Frequency of stimulation (i.e. shortening the intervals between the stimuli)  $\uparrow \rightarrow$  force of contraction  $\uparrow$  (intracellular  $\text{Ca}^{+2}$  content  $\uparrow$ ) (positive chronotropic effect)

# Contractility

- Extra cardiac factor
  - Neural factor: sympathetic stimulation and noradrenaline  
↑ by increasing cyclic-AMP (activation of the  $\text{Ca}^{2+}$  channels) & heart rate
  - Physical factor: body temperature
    - A moderate rise (↑  $\text{Ca}^{2+}$  influx and ATP formation) → ↑
    - An excessive rise (e.g. fever) → exhausts the metabolic substrates in cardiac muscle → ↓

# Contractility

- Chemical factor:
  - Hormones: catecholamines (epinephrine, norepinephrine, dopamine)  $\rightarrow \uparrow$
  - Blood gases: moderate hypoxia, hypercapnia  $\rightarrow \uparrow$
  - pH: alkalosis  $\rightarrow \uparrow$ ; acidosis  $\rightarrow \downarrow$
  - Toxins  $\rightarrow \downarrow$
  - Inorganic ions:  $[K^+] \uparrow$ ,  $[Na^+] \uparrow$ ,  $[Ca^{2+}] \downarrow \rightarrow \downarrow$
  - Drugs: Digoxin  $\rightarrow \uparrow$ ,  $Ca^{2+}$  blocker  $\rightarrow \downarrow$

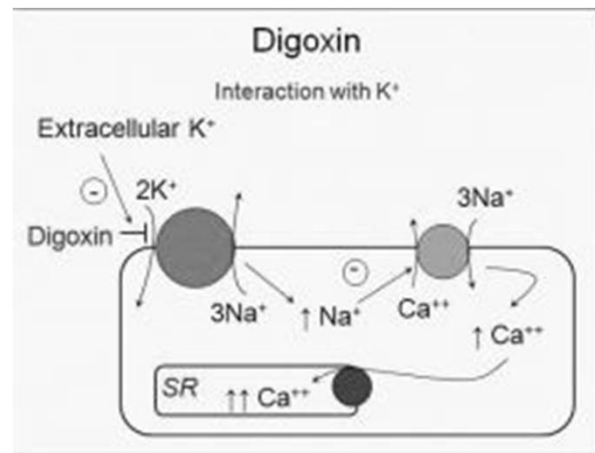

# Mechanism of Cardiac Muscle Excitation, Contraction, & Relaxation (Lusitropic effect)

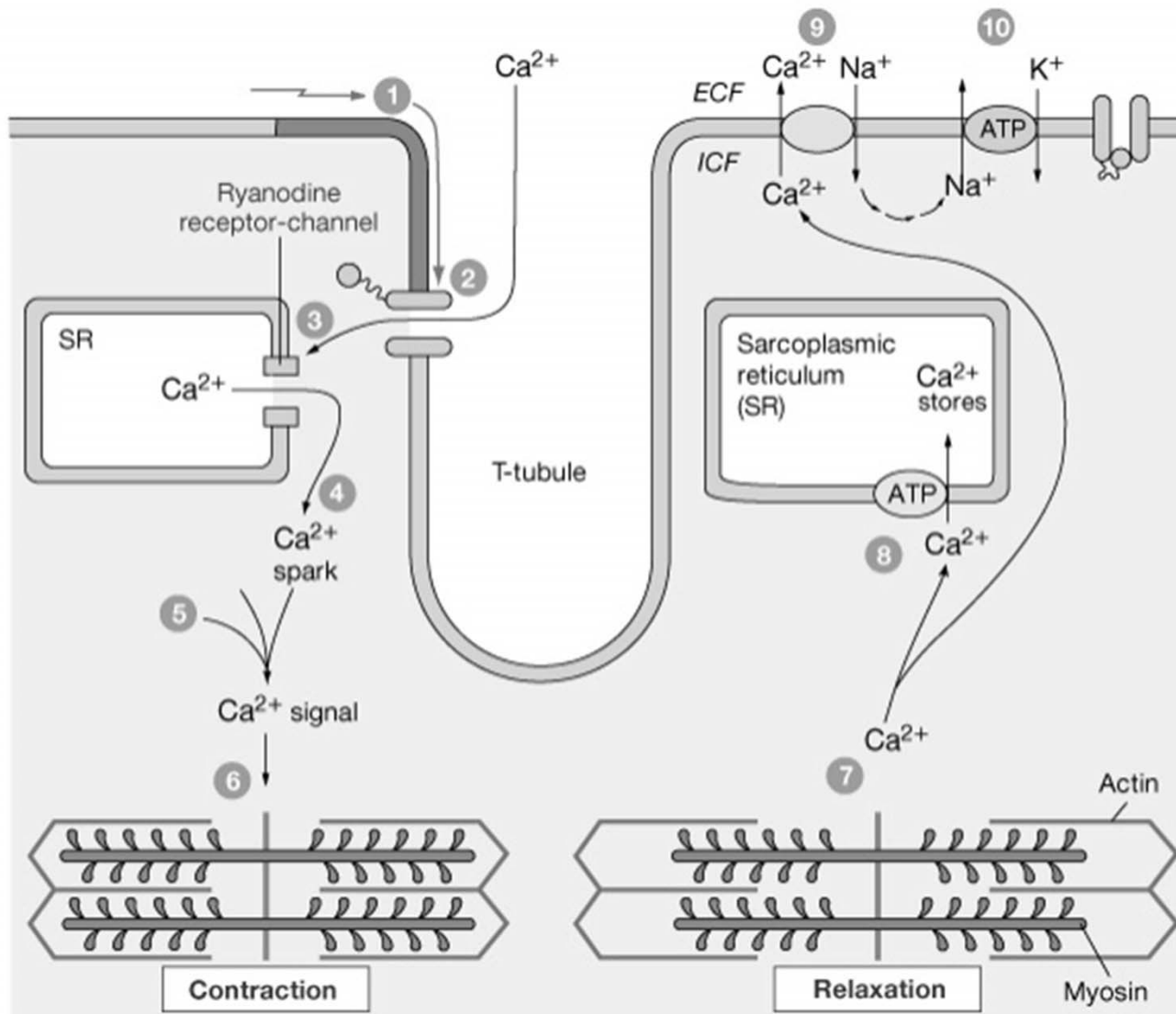

- 1 Action potential enters from adjacent cell.
- 2 Voltage-gated  $\text{Ca}^{2+}$  channels open.  $\text{Ca}^{2+}$  enters cell.
- 3  $\text{Ca}^{2+}$  induces  $\text{Ca}^{2+}$  release through ryanodine receptor-channels (RyR).
- 4 Local release causes  $\text{Ca}^{2+}$  spark.
- 5 Summed  $\text{Ca}^{2+}$  sparks create a  $\text{Ca}^{2+}$  signal.
- 6  $\text{Ca}^{2+}$  ions bind to troponin to initiate contraction.
- 7 Relaxation occurs when  $\text{Ca}^{2+}$  unbinds from troponin.
- 8  $\text{Ca}^{2+}$  is pumped back into the sarcoplasmic reticulum for storage.
- 9  $\text{Ca}^{2+}$  is exchanged with  $\text{Na}^{+}$ .
- 10  $\text{Na}^{+}$  gradient is maintained by the  $\text{Na}^{+}$ - $\text{K}^{+}$ -ATPase.

# Quiz\_20

If a drug has a positive inotropic effect on heart, which means this drug can increase heart's

- (A) heart rate
- (B) conductivity
- (C) contractility
- (D) relaxation
- (E) excitability

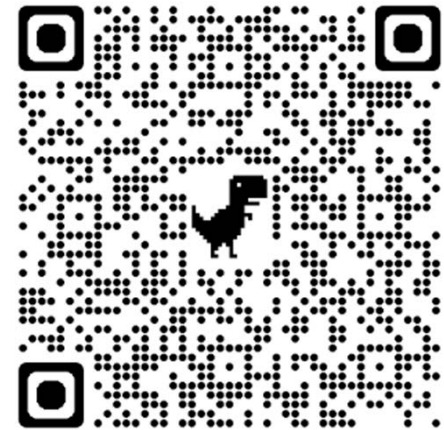

<https://forms.gle/yLFVViVMxi1V4vKD6>

# Excitation Contraction: Cardiac vs. Skeletal M.

## Skeletal muscle:

- Dihydropyridine (DHP) receptor acts as voltage sensor (not as channel)
- DHP receptor mechanically opens ryanodine receptor channel
- $\text{Ca}^{2+}$  enters cytosol from sarcoplasmic reticulum → contraction

## Cardiac muscle:

- DHP receptor (L-type  $\text{Ca}^{2+}$  channel) acts as voltage gated channel
- $\text{Ca}^{2+}$  enters cytosol from T tubules
- $\text{Ca}^{2+}$  from T tubules stimulates opening of ryanodine receptor channel
- $\text{Ca}^{2+}$  enters cytosol from sarcoplasmic reticulum → contraction

# Goals of the Lecture

- Explain the process of skeletal m. contraction
- Explain how to control skeletal m. contraction
- Interpret the mechanics of skeletal m. contraction
- Summarize the energetics of skeletal m. contraction
  
- Restate the process of smooth m. contraction and relaxation
- Classify different types of smooth m.
  
- Describe the characteristics of cardiac m.
  
- Differentiate the difference among three types of muscle





# Comparison of Skeletal, Cardiac, and Smooth Muscle



CHARACTERISTIC	SKELETAL	CARDIAC	SMOOTH
Body location	Attached to bones or (some facial muscles) to skin	Walls of the heart	Unitary muscle in walls of hollow visceral organs (other than the heart); multi unit muscle in intrinsic eye muscles, airways, large arteries
Cell shape and appearance	Single, very long, cylindrical, multinucleate cells with obvious striations	Branching chains of cells; uni- or binucleate; striations	Single, fusiform, uninucleate; no striations



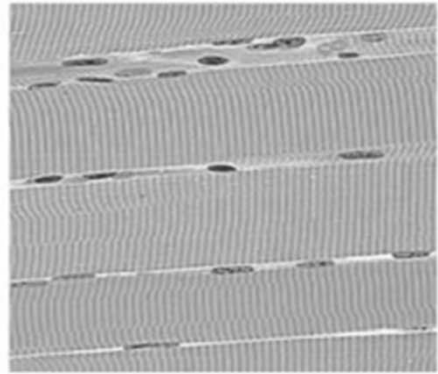



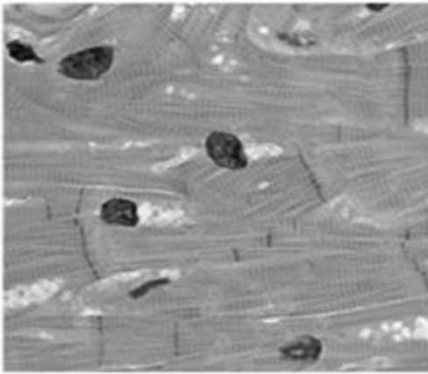



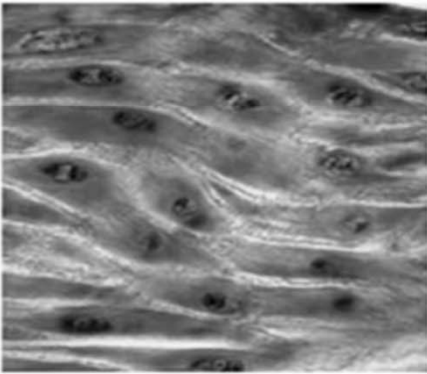





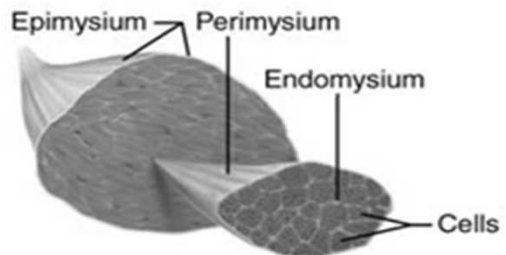
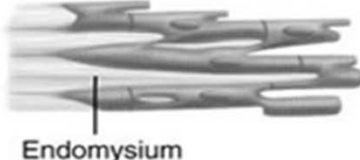
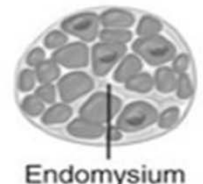
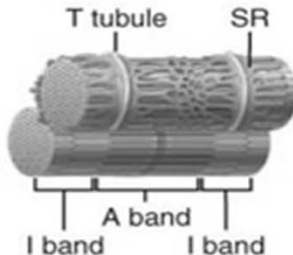
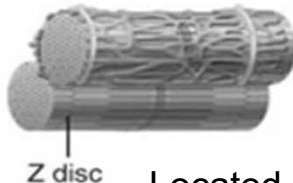
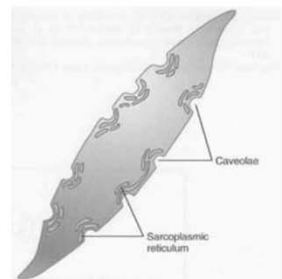

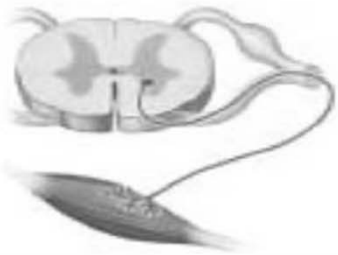
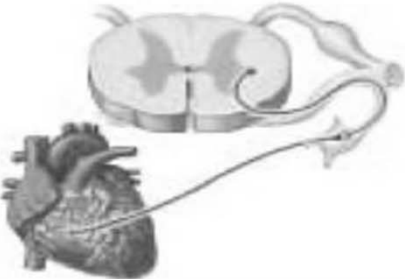
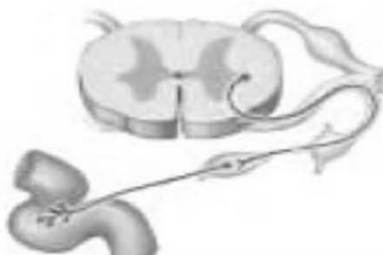

# Comparison of Skeletal, Cardiac, and Smooth Muscle

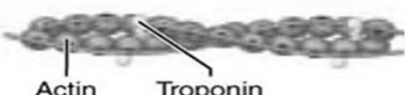
CHARACTERISTIC	SKELETAL	CARDIAC	SMOOTH
Connective tissue components	Epimysium, perimysium, and endomysium 	Endomysium attached to fibrous skeleton of heart 	Endomysium 
Presence of myofibrils composed of sarcomeres	Yes	Yes, but myofibrils are of irregular thickness	No, but actin and myosin filaments are present throughout; dense bodies anchor actin filaments
Presence of T tubules and site of invagination	Yes; two in each sarcomere at A-I junctions <p>Located at the junction of A band and I band</p> 	Yes; one in each sarcomere at Z disc; larger diameter than those of skeletal muscle  <p>Located at Z disc</p>	No; only caveolae 
Elaborate sarcoplasmic reticulum	Yes	Less than skeletal muscle (1–8% of cell volume); scant terminal cisterns	Equivalent to cardiac muscle (1–8% of cell volume); some SR contacts the sarcolemma

# Comparison of Skeletal, Cardiac, and Smooth Muscle

CHARACTERISTIC	SKELETAL	CARDIAC	SMOOTH
Presence of gap junctions	No	Yes; at intercalated discs	Yes; in unitary muscle
Cells exhibit individual neuromuscular junctions	Yes 	No	Not in unitary muscle; yes in multi unit muscle 
Regulation of contraction	Voluntary via axon terminals of the somatic nervous system 	Involuntary; intrinsic system regulation; also autonomic nervous system controls; hormones; stretch 	Involuntary; autonomic nerves, hormones, local chemicals; stretch 
Source of Ca <sup>2+</sup> for calcium pulse	Sarcoplasmic reticulum (SR)	SR and from extracellular fluid	SR and from extracellular fluid
Site of calcium regulation	Troponin on actin-containing thin filaments 	Troponin on actin-containing thin filaments 	Calmodulin in the cytosol 

# Comparison of Skeletal, Cardiac, and Smooth Muscle

CHARACTERISTIC	SKELETAL	CARDIAC	SMOOTH
Presence of pacemaker(s)	No	Yes	Yes (in unitary muscle only)
Effect of nervous system stimulation	Excitation	Excitation or inhibition	Excitation or inhibition
Speed of contraction	Slow to fast	Slow	Very slow
			
Rhythmic contraction	No	Yes	Yes in unitary muscle
Response to stretch	Contractile strength increases with degree of stretch (to a point)	Contractile strength increases with degree of stretch	Stress-relaxation response Fast stretch causes contraction
Respiration	Aerobic and anaerobic	Aerobic	Mainly aerobic

**The End!**